

**INSTRUMENT  
APPROACH  
CHART**

**AERODROME ELEV 13 ft**  
**HEIGHTS RELATED TO**  
**RWY 36L ELEV TDZ 13 ft**

GIMHAE APP 125.5 364.0  
GIMHAE TWR 118.1 118.45  
233.3 236.6

**BUSAN/Gimhae Intl(RKPK)**  
**ILS RWY 36L**  
**CAT II**

Note : Approach and circle to land under U.S. TERPS.

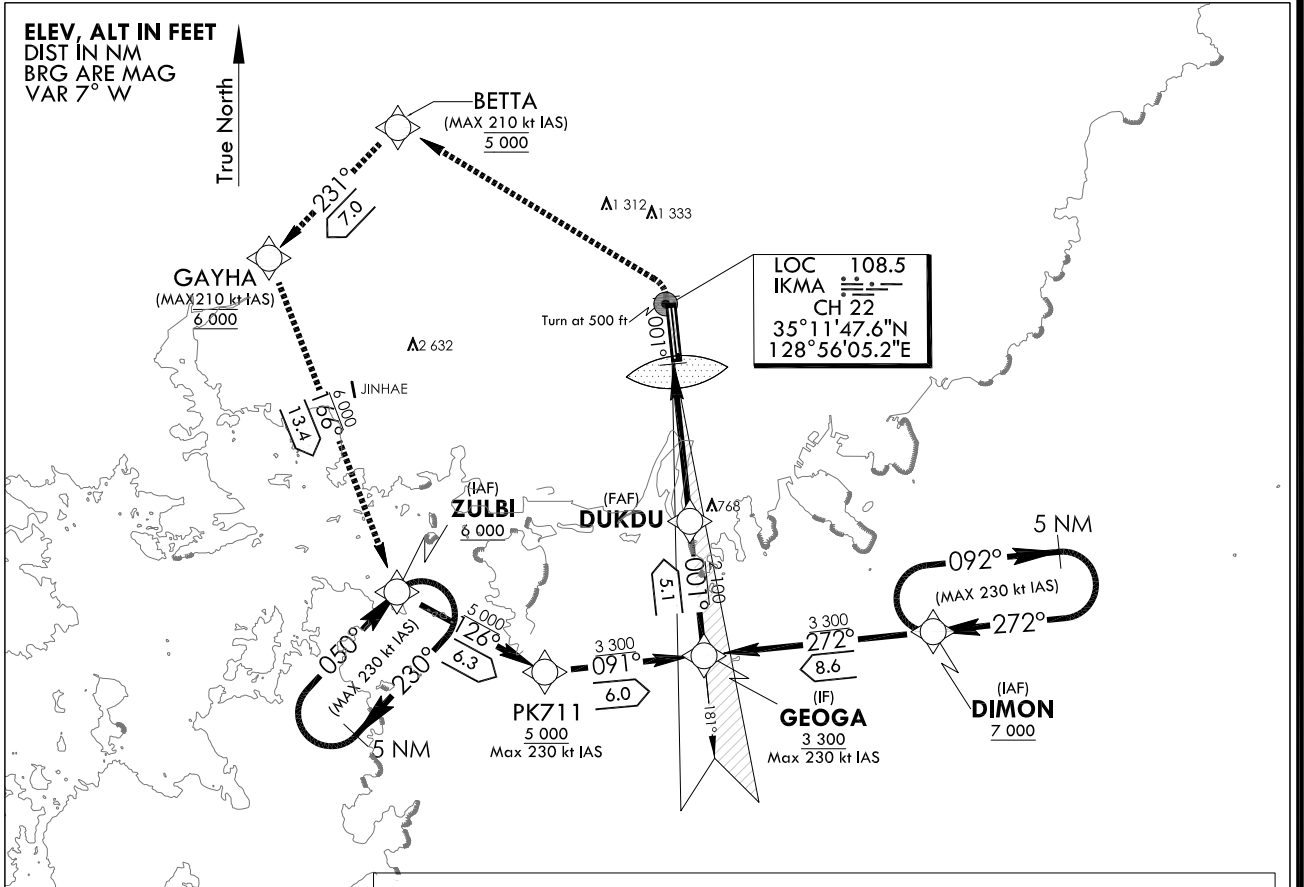

1. RNAV 1.0 Required.
  2. Circling is not authorized.
  3. Missed approach requires minimum climb of 420 ft/NM to 5 000 ft.  
If unable to meet climb gradient, advise ATC and see ILS Y RWY 36L or ILS Z RWY 36L.
  4. Limited approach to MAX 230 kt IAS and missed approach to MAX 210 kt IAS.
  5. CATEGORY II ILS - SPECIAL AIRCREW & AIRCRAFT CERTIFICATION REQUIRED.
- NOT TO SCALE** **GNSS and RADAR Required.**

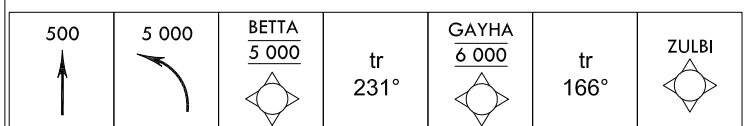

TRANSITION ALT 14 000  
TRANSITION LVL FL 140

NOTE : VGSI and ILS glidepath not coincident  
(VGSI Angle 3.00° TCH 67).

**MISSED APPROACH**  
Climb to 500, then climbing left to 5 000 direct BETTA, then track 231° to GAYHA, then track 166° to ZULBI and HOLD.

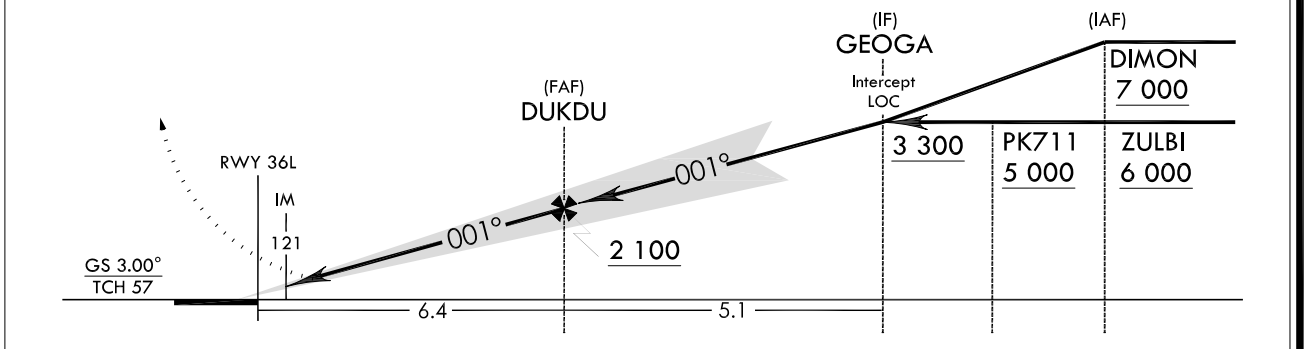

CATEGORY	A	B	C	D
S-ILS 36L	RA* 102/12	100	DA 113	

\* Radio Altimeter Height

Change : New procedures.

**BUSAN/Gimhae INTL(RKPK)**  
**ILS RWY 36L**  
**CAT II**

**AERONAUTICAL DATA TABULATION**

**Instrument Approach Procedure Coding Tables**

ILS RWY 36L CAT II - via DIMON to GEOGA(IF)

Serial Number	Path Descriptor	Waypoint Identifier	Fly-over	Course/Track °M(T)	Distance (NM)	Turn direction	Altitude (ft)	Speed (kt)	Coordinates	VPA/TCH	Navigation specification	Remarks
001	-	DIMON	-	-	-	-	+7 000	-230	34°59'23.1"N 129°08'15.3"E	-	RNAV 1	IAF
002	TF	GEOGA	-	271.5(264.1)	8.6	-	+3 300	-230	34°58'29.0"N 128°57'48.0"E	-	RNAV 1	IF

ILS RWY 36L CAT II - via ZULBI to GEOGA(IF)

Serial Number	Path Descriptor	Waypoint Identifier	Fly-over	Course/Track °M(T)	Distance (NM)	Turn direction	Altitude (ft)	Speed (kt)	Coordinates	VPA/TCH	Navigation specification	Remarks
001	-	ZULBI	-	-	-	-	+6 000	-230	35°00'51.7"N 128°43'47.2"E	-	RNAV 1	IAF
002	TF	PK711	-	125.8(118.3)	6.3	-	+5 000	-230	34°57'51.9"N 128°50'32.3"E	-	RNAV 1	SDF
002	TF	GEOGA	-	091.5(084.1)	6.0	-	+3 300	-230	34°58'29.0"N 128°57'48.0"E	-	RNAV 1	IF

ILS RWY 36L CAT II - via GEOGA(IF) to MAHF

Serial Number	Path Descriptor	Waypoint Identifier	Fly-over	Course/Track °M(T)	Distance (NM)	Turn direction	Altitude (ft)	Speed (kt)	Coordinates	VPA/TCH	Navigation specification	Remarks
001	TF	GEOGA	-	-	-	-	+3 300	-230	34°58'29.0"N 128°57'48.0"E	-	RNAV 1	IF
002	TF	DUKDU	-	001.4(354.0)	5.1	-	+2 100	-	35°03'32.1"N 128°57'09.1"E	-	-	FAF
003	-	DA	-	001.4(354.0)	-	-	+113	-	-	-	LOC	DA
004	-	RWY 36L	-	001.4(354.0)	-	-	-	-	35°09'54.7"N 128°56'19.8"E	3.0/57	LOC	-
005	VA	-	-	001.4(354.0)	-	-	+500	-210	-	-	RNAV 1	CG 420 ft/NM to 5 000
006	DF	BETTA	-	-	-	L	@5 000	-210	35°18'24.2"N 128°43'46.2"E	-	RNAV 1	-
007	TF	GAYHA	-	231.2(223.8)	7.0	-	@6 000	-210	35°13'22.4"N 128°37'54.4"E	-	RNAV 1	-
008	TF	ZULBI	-	166.3(158.9)	13.4	-	+6 000	-230	35°00'51.7"N 128°43'47.2"E	-	RNAV 1	-

**HOLDING PROCEDURE**

Holding Identification	Path Descriptor	Waypoint Identifier	Fly-over	Course/Track °M(T)	Distance (NM)	Turn direction	Altitude (ft)	Speed (kt)	Coordinates	VPA/TCH	Navigation specification	Remarks
ILS RWY 36L CAT II	HM	DIMON	-	271.7 (264.2)	5.0	R	+7 000	-230	34°59'23.1"N 129°08'15.3"E	-	RNAV 1	Hold at DIMON E Right Turn 272° Inbound 5 NM Leg.
	HM	ZULBI	-	050 (042.5)	5.0	R	+6 000	-230	35°00'51.7"N 128°43'47.2"E	-	RNAV 1	Hold at ZULBI SW Right Turn 050° Inbound 5 NM Leg.

Change : New procedures.

**INSTRUMENT  
APPROACH  
CHART**

**AERODROME ELEV** 13 ft  
**HEIGHTS RELATED TO  
RWY 36L ELEV TDZ** 13 ft

GIMHAE APP 125.5 364.0  
GIMHAE TWR 118.1 118.45  
233.3 236.6

**BUSAN/Gimhae Intl(RKPK)**  
**ILS Y**  
**RWY 36L**

Note : Approach and circle to land under U.S. TERPS.

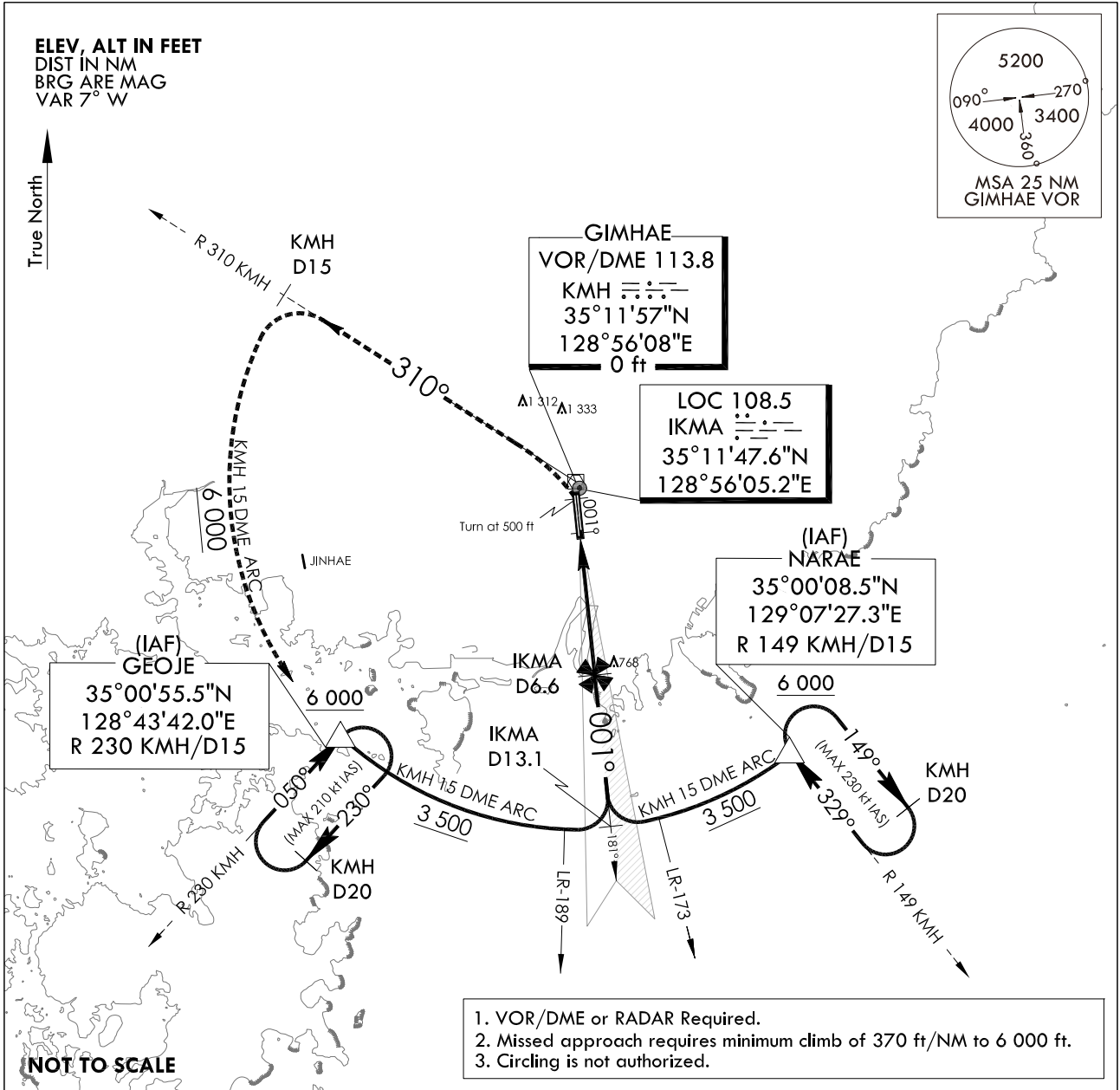

**NOTE**  
Use IKMA DME when on the localizer course.  
VGSI and ILS glidepath not coincident(VGSI Angle 3.00° TCH 67).

TRANSITION ALT 14 000  
TRANSITION LVL FL 140

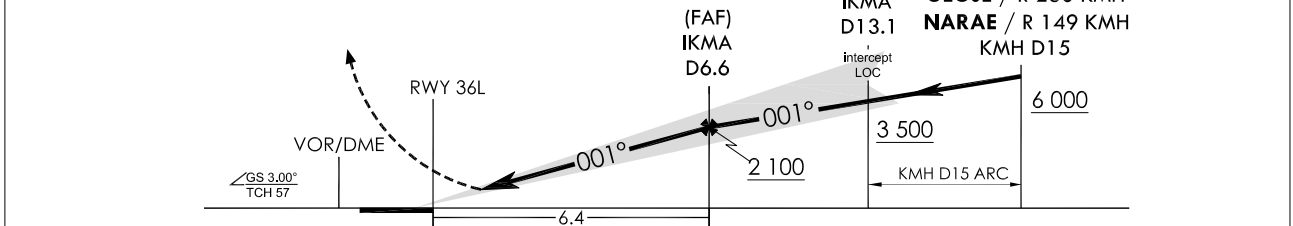

CATEGORY	A	B	C	D
S-ILS 36L	213/18	200 (200 - 1/2)	213/24*	200(200-1/2) (*Use civil only RVR 18)
	When TDZ/CL LGT INOP, increase RVR to 24			
ALS INOP	213/40 200(200 - 3/4)			

Change : Page control.

**INTENTIONALLY**

**LEFT**

**BLANK**

**INSTRUMENT  
APPROACH  
CHART**

**AERODROME ELEV** 13 ft  
**HEIGHTS RELATED TO  
RWY 36L ELEV TDZ** 13 ft

GIMHAE APP 125.5 364.0  
GIMHAE TWR 118.1 118.45  
233.3 236.6

**BUSAN/Gimhae Intl(RKPK)  
LOC/DME Y  
RWY 36L**

Note : Approach and circle to land under U.S. TERPS.

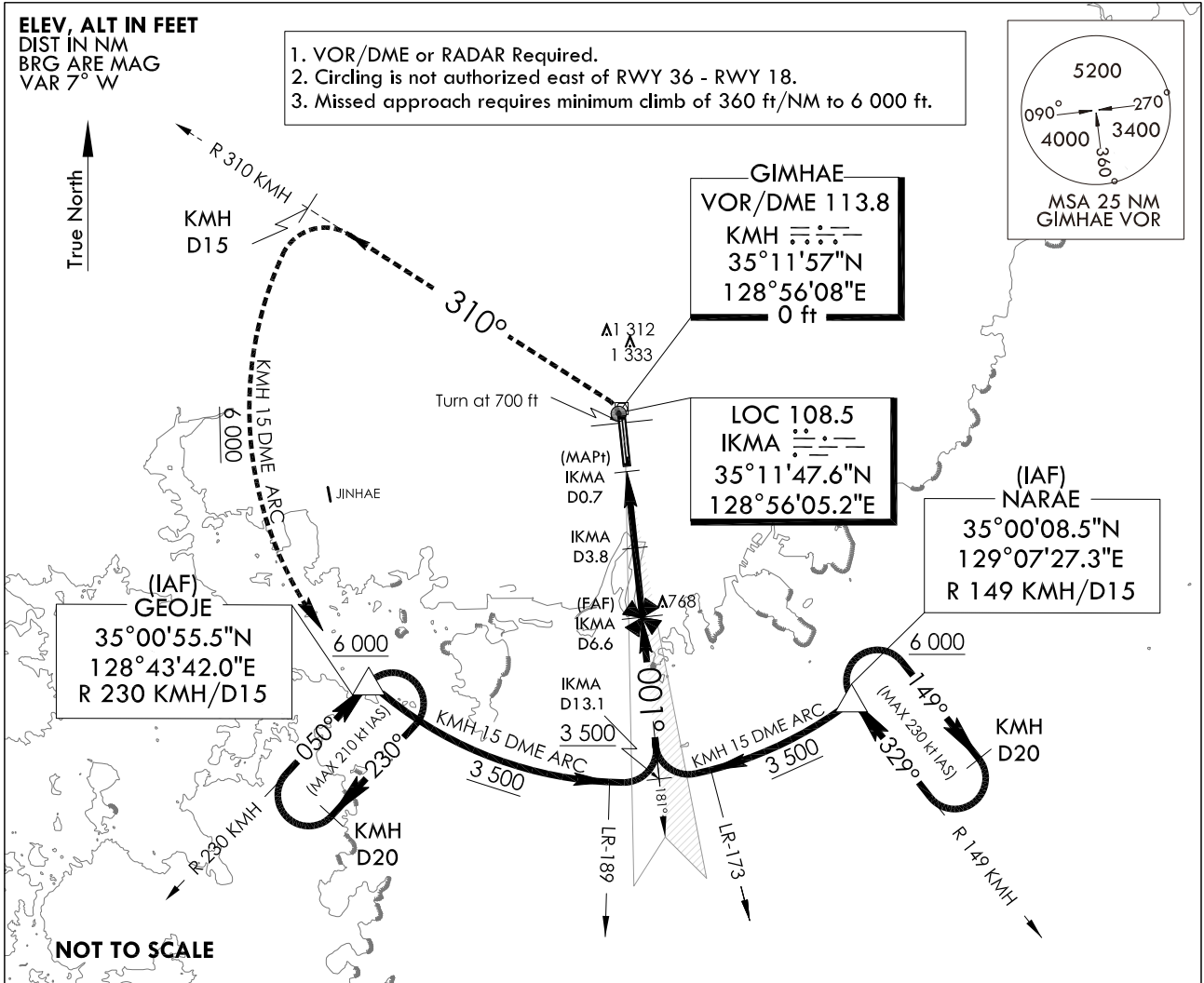

**MISSED APPROACH**  
Climb to 700 ft, then left turn climbing 6 000 ft on R 310 KMH to 15 DME, then arc KMH 15 DME to GEOJE and hold.

**NOTE**  
Use IKMA DME when on the localizer course.

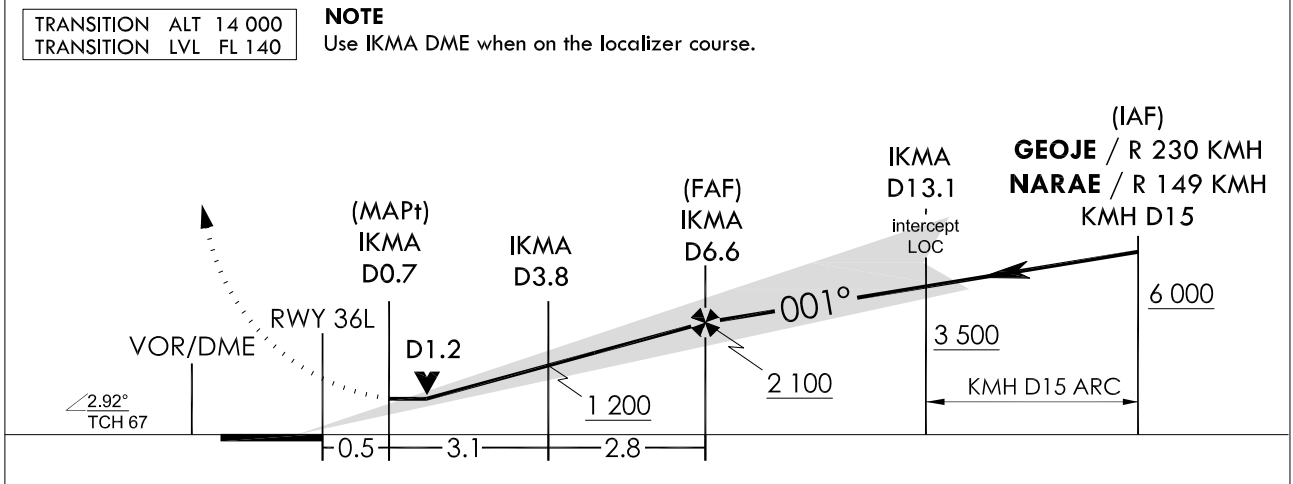

CATEGORY	A	B	C	D
S-LOC 36L	400/24 388(400 - 1/2)		400/35 388(400 - 5/8)	
ALS INOP	400/55 388(400 - 1)		400/60 388(400 - 1 1/8)	
CIRCLING	520-1 507(600 - 1)	580-1 567(600 - 1)	1 360 - 3 1 347(1 400 - 3)	1 700 - 3 1 687(1 700 - 3)

Change : Page control.

**INTENTIONALLY**

**LEFT**

**BLANK**

**INSTRUMENT  
APPROACH  
CHART**

**AERODROME ELEV 13 ft**  
**HEIGHTS RELATED TO**  
**RWY 36L ELEV TDZ 13 ft**

GIMHAE APP 125.5 364.0  
GIMHAE TWR 118.1 118.45  
233.3 236.6

**BUSAN/Gimhae Intl(RKPK)**  
**ILS Z**  
**RWY 36L**

Note : Approach and circle to land under U.S. TERPS.

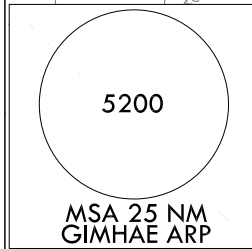
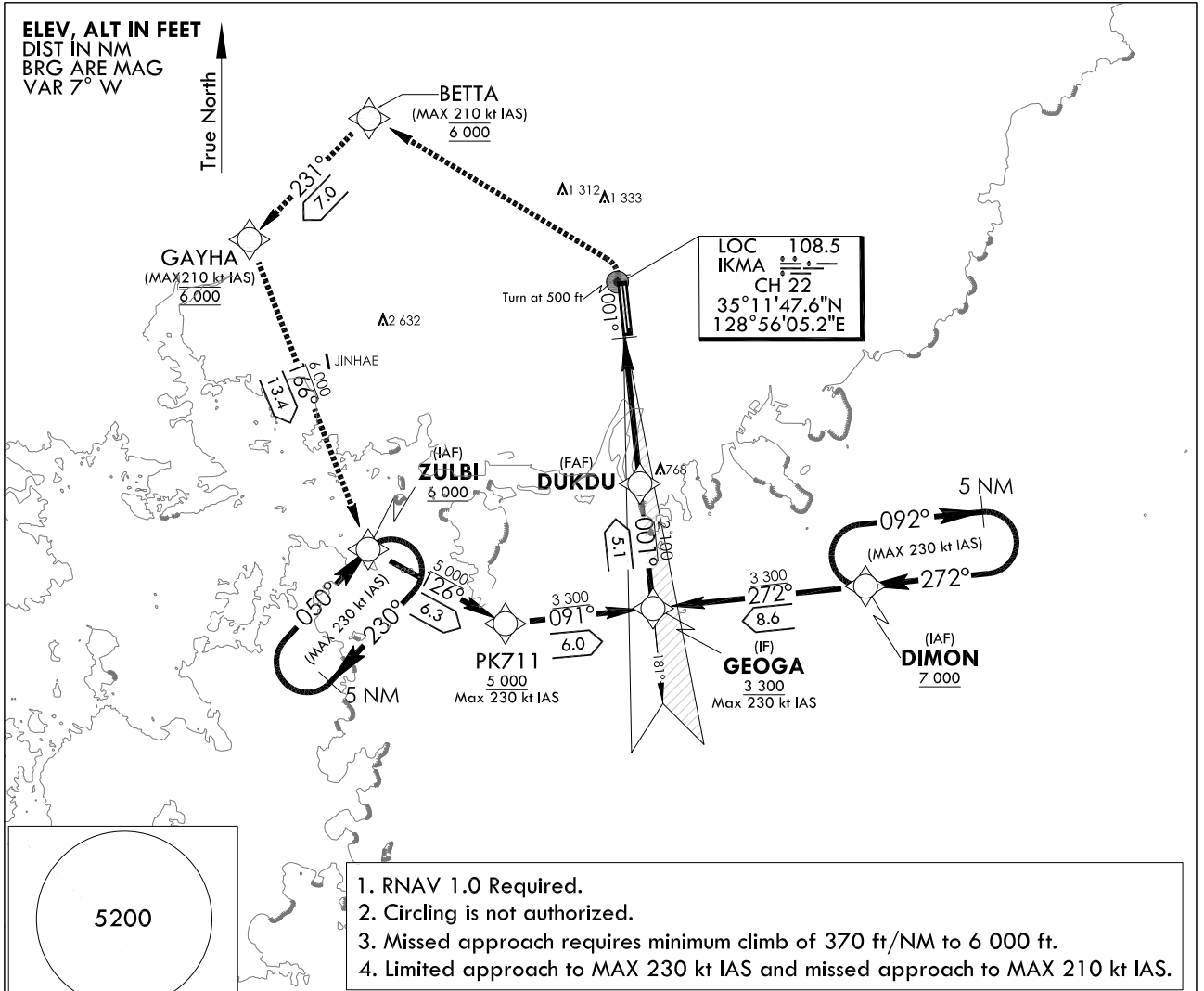

1. RNAV 1.0 Required.
2. Circling is not authorized.
3. Missed approach requires minimum climb of 370 ft/NM to 6000 ft.
4. Limited approach to MAX 230 kt IAS and missed approach to MAX 210 kt IAS.

**NOT TO SCALE**

**GNSS and RADAR Required.**

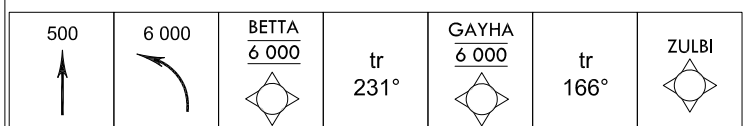

TRANSITION ALT 14 000  
TRANSITION LVL FL 140

**MISSED APPROACH**  
Climb to 500, then climbing left to 6000 direct BETTA, then track 231° to GAYHA, then track 166° to ZULBI and HOLD.

NOTE : Use IKMA DME when on the localizer course.  
NOTE : VGSI and ILS glidepath not coincident (VGSI Angle 3.00° TCH 67).

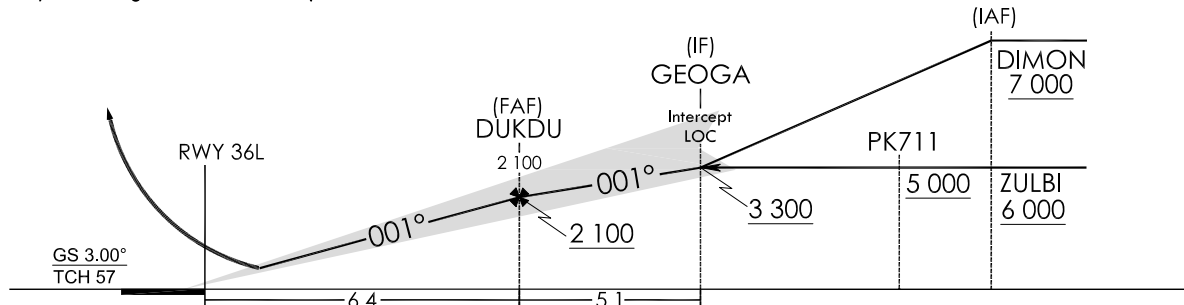

CATEGORY	A	B	C	D
S-ILS 36L		213/18	200(200 - 1/2)	
		When TDZ/CL LGT INOP, increase RVR to 24		
ALS INOP		213/40	200(200 - 3/4)	

Change : Page control.

BUSAN/Gimhae INTL(RKPK)

ILS Z  
RWY 36L

AERONAUTICAL DATA TABULATION

Instrument Approach Procedure Coding Tables

ILS Z RWY 36L - via DIMON to GEOGA(IF)

Serial Number	Path Descriptor	Waypoint Identifier	Fly-over	Course/Track °M(°T)	Distance (NM)	Turn direction	Altitude (ft)	Speed (kt)	Coordinates	VPA/TCH	Navigation specification	Remarks
001	-	DIMON	-	-	-	-	+7 000	-230	34°59'23.1"N 129°08'15.3"E	-	RNAV 1	IAF
002	TF	GEOGA	-	271.5(264.1)	8.6	-	+3 300	-230	34°58'29.0"N 128°57'48.0"E	-	RNAV 1	IF

ILS Z RWY 36L - via ZULBI to GEOGA(IF)

Serial Number	Path Descriptor	Waypoint Identifier	Fly-over	Course/Track °M(°T)	Distance (NM)	Turn direction	Altitude (ft)	Speed (kt)	Coordinates	VPA/TCH	Navigation specification	Remarks
001	-	ZULBI	-	-	-	-	+6 000	-230	35°00'51.7"N 128°43'47.2"E	-	RNAV 1	IAF
002	TF	PK711	-	125.8(118.3)	6.3	-	+5 000	-230	34°57'51.9"N 128°50'32.3"E	-	RNAV 1	SDF
002	TF	GEOGA	-	091.5(084.1)	6.0	-	+3 300	-230	34°58'29.0"N 128°57'48.0"E	-	RNAV 1	IF

ILS Z RWY 36L - via GEOGA(IF) to MAHF

Serial Number	Path Descriptor	Waypoint Identifier	Fly-over	Course/Track °M(°T)	Distance (NM)	Turn direction	Altitude (ft)	Speed (kt)	Coordinates	VPA/TCH	Navigation specification	Remarks
001	TF	GEOGA	-	-	-	-	+3 300	-230	34°58'29.0"N 128°57'48.0"E	-	RNAV 1	IF
002	TF	DUKDU	-	001.4(354.0)	5.1	-	+2 100	-	35°03'32.1"N 128°57'09.1"E	-	-	FAF
003	-	DA	-	001.4(354.0)	-	-	-	-	-	-	LOC	DA
004	-	RWY 36L	-	001.4(354.0)	-	-	-	-	35°09'54.7"N 128°56'19.8"E	3.0/57	LOC	-
005	VA	-	-	001.4(354.0)	-	-	+500	-210	-	-	RNAV 1	CG 370 ft/NM to 6 000
006	DF	BETTA	-	-	-	L	@6 000	-210	35°18'24.2"N 128°43'46.2"E	-	RNAV 1	-
007	TF	GAYHA	-	231.2(223.8)	7.0	-	@6 000	-210	35°13'22.4"N 128°37'54.4"E	-	RNAV 1	-
008	TF	ZULBI	-	166.3(158.9)	13.4	-	+6 000	-230	35°00'51.7"N 128°43'47.2"E	-	RNAV 1	-



**INSTRUMENT  
APPROACH  
CHART**

**AERODROME ELEV 13 ft  
HEIGHTS RELATED TO  
RWY 36L ELEV TDZ 13 ft**

GIMHAE APP 125.5 364.0  
GIMHAE TWR 118.1 118.45  
233.3 236.6

**BUSAN/Gimhae Intl(RKPK)  
LOC/DME Z  
RWY 36L**

Note : Approach and circle to land under U.S. TERPS.

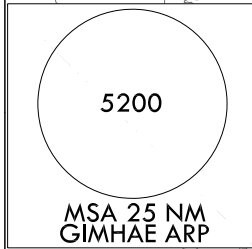
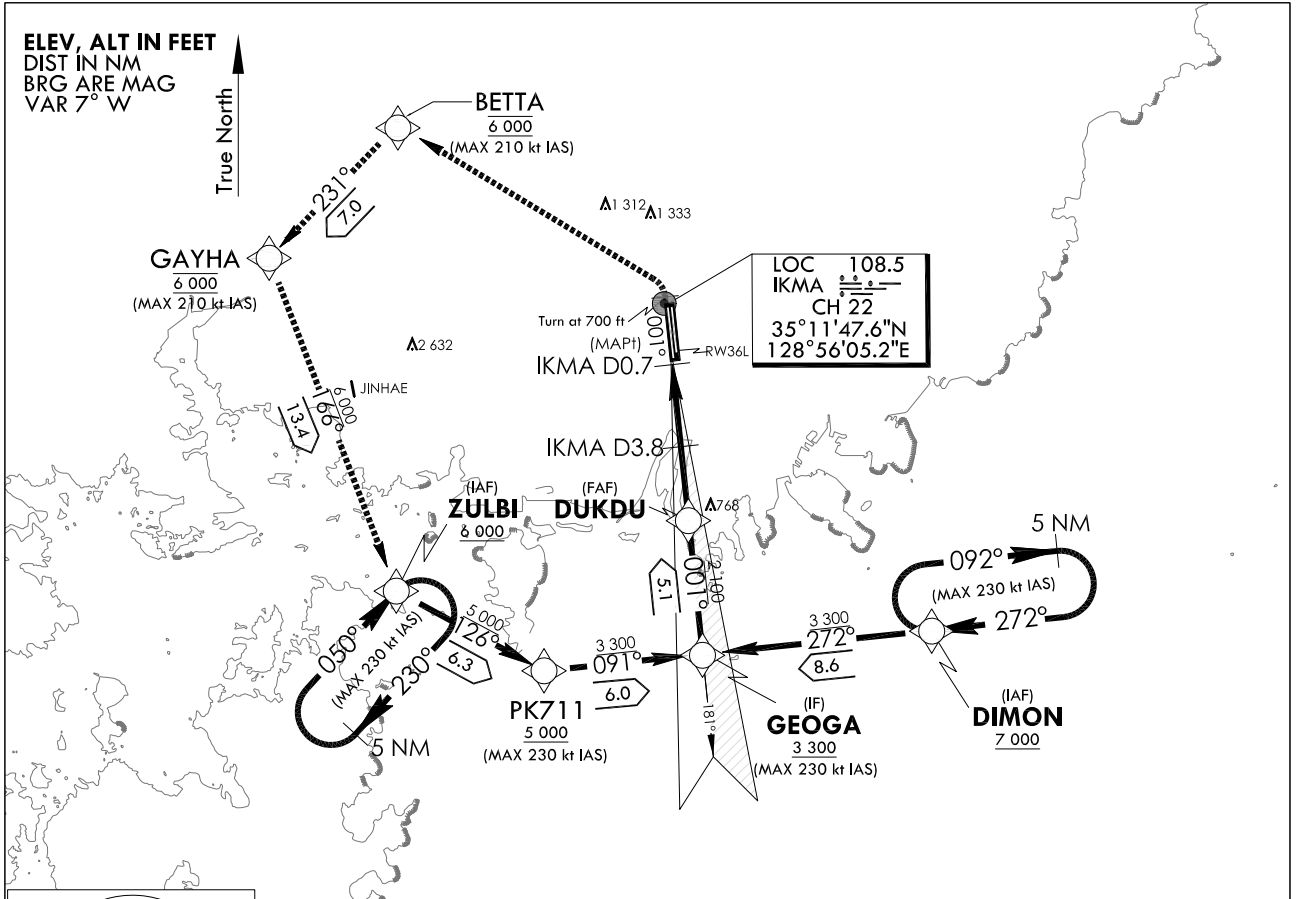

1. RNAV 1.0 Required.
2. Circling is not authorized east of RWY 36 - RWY 18.
3. Missed approach requires minimum climb of 360 ft/NM to 6 000 ft.
4. Limited approach to MAX 230 kt IAS and missed approach to MAX 210 kt IAS.

**NOT TO SCALE**

**GNSS and RADAR Required.**

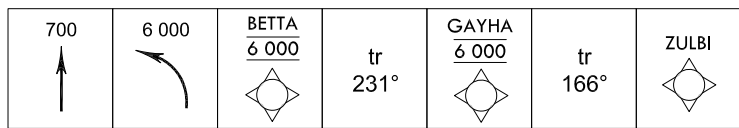

TRANSITION ALT 14 000  
TRANSITION LVL FL 140

NOTE : Use IKMA DME when on the localizer course.

**MISSED APPROACH**

Climb to 700, then climbing left to 6 000 direct BETTA, then track 231° to GAYHA, then track 166° to ZULBI and HOLD.

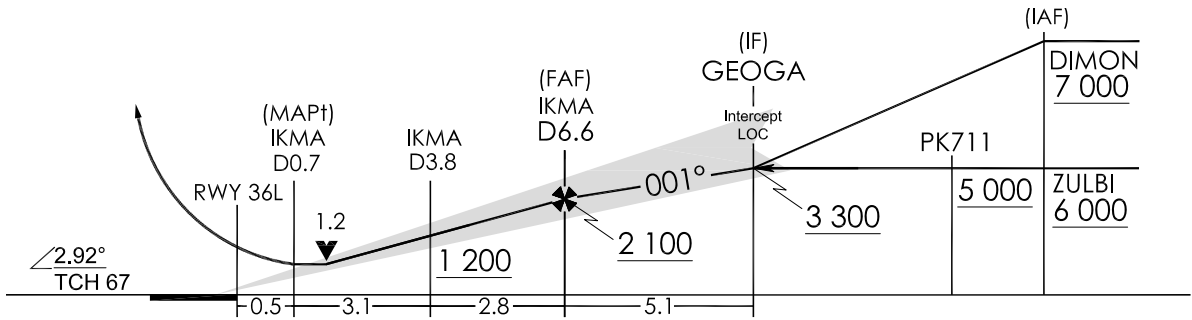

CATEGORY	A	B	C	D
S-LOC 36L	400/24 388(400 - 1/2)		400/35 388(400 - 5/8)	
ALS INOP	400/55 388(400 - 1)		400/60 388(400 - 1 1/8)	
CIRCLING	520-1 507(600 - 1)	580-1 567(600 - 1)	1 360 - 3 1 347(1 400 - 3)	1 700 - 3 1 687(1 700 - 3)

Change : Page control.

BUSAN/Gimhae INTL(RKPK)  
LOC/DME Z  
RWY 36L

AERONAUTICAL DATA TABULATION

Instrument Approach Procedure Coding Tables

LOC/DME Z RWY 36L - via DIMON to GEOGA(IF)

Serial Number	Path Descriptor	Waypoint Identifier	Fly-over	Course/Track °M(°T)	Distance (NM)	Turn direction	Altitude (ft)	Speed (kt)	Coordinates	VPA/TCH	Navigation specification	Remarks
001	-	DIMON	-	-	-	-	+7 000	-230	34°59'23.1"N 129°08'15.3"E	-	RNAV 1	IAF
002	TF	GEOGA	-	271.5(264.1)	8.6	-	+3 300	-230	34°58'29.0"N 128°57'48.0"E	-	RNAV 1	IF

LOC/DME Z RWY 36L - via ZULBI to GEOGA(IF)

Serial Number	Path Descriptor	Waypoint Identifier	Fly-over	Course/Track °M(°T)	Distance (NM)	Turn direction	Altitude (ft)	Speed (kt)	Coordinates	VPA/TCH	Navigation specification	Remarks
001	-	ZULBI	-	-	-	-	+6 000	-230	35°00'51.7"N 128°43'47.2"E	-	RNAV 1	IAF
002	TF	PK711	-	125.8(118.3)	6.3	-	+5 000	-230	34°57'51.9"N 128°50'32.3"E	-	RNAV 1	SDF
002	TF	GEOGA	-	091.5(084.1)	6.0	-	+3 300	-230	34°58'29.0"N 128°57'48.0"E	-	RNAV 1	IF

LOC/DME Z RWY 36L - via GEOGA(IF) to MAHF

Serial Number	Path Descriptor	Waypoint Identifier	Fly-over	Course/Track °M(°T)	Distance (NM)	Turn direction	Altitude (ft)	Speed (kt)	Coordinates	VPA/TCH	Navigation specification	Remarks
001	TF	GEOGA	-	-	-	-	+3 300	-230	34°58'29.0"N 128°57'48.0"E	-	RNAV 1	IF
002	TF	DUKDU	-	001.4(354.0)	5.1	-	+2 100	-	35°03'32.1"N 128°57'09.1"E	-	LOC	FAF
003	-	IKMA 3.8D	-	001.4(354.0)	2.8	-	+1 200	-	-	-	LOC	SDF
004	-	IKMA 0.7D	-	001.4(354.0)	3.1	-	+400	-	-	-	LOC	MAPt
005	-	RWY 36L	-	001.4(354.0)	0.5	-	-	-	-	3.0/67	LOC	-
006	VA	-	-	001.4(354.0)	-	-	+700	-210	35°18'24.2"N 128°43'46.2"E	-	RNAV 1	CG 360 ft/NM to 6 000
007	DF	BETTA	-	-	-	L	@6 000	-210	35°13'22.4"N 128°37'54.4"E	-	RNAV 1	CG 360 ft/NM to 6 000
008	TF	GAYHA	-	231.2(223.8)	7.0	-	@6 000	-210	35°00'51.7"N 128°43'47.2"E	-	RNAV 1	-
009	TF	ZULBI	-	166.3(158.9)	13.4	-	+6 000	-230	-	-	RNAV 1	-

Change : Page control.

**INSTRUMENT APPROACH CHART**

**AERODROME ELEV 13 ft**  
HEIGHTS RELATED TO  
**RWY 36L ELEV TDZ 13 ft**

GIMHAE APP 125.5 364.0  
GIMHAE TWR 118.1 118.45  
233.3 236.6

**BUSAN/Gimhae Intl(RKPK)**  
**RNAV(GNSS)**  
**RWY 36L**

Note : Approach and circle to land under U.S. TERPS.

**ELEV, ALT IN FEET**  
DIST IN NM  
BRG ARE MAG  
VAR 7° W

**NOTE :**

1. RNP 0.3 Required.
2. DME/DME RNP 0.3 N/A.
3. Missed approach requires minimum climb of 390 ft/NM to 6 000 ft.
4. Limit initial and missed approach to Max 230 kt IAS.
5. Limit PK723 to Max 210 kt IAS.
6. Bank angle used 23 degrees : PK723, BETTA.
7. Circling is not authorized east of RWY 36/18.
8. For uncompensated Baro-VNAV system, LNAV/VNAV N/A below -18°C(0°F) or above 54°C(130°F).

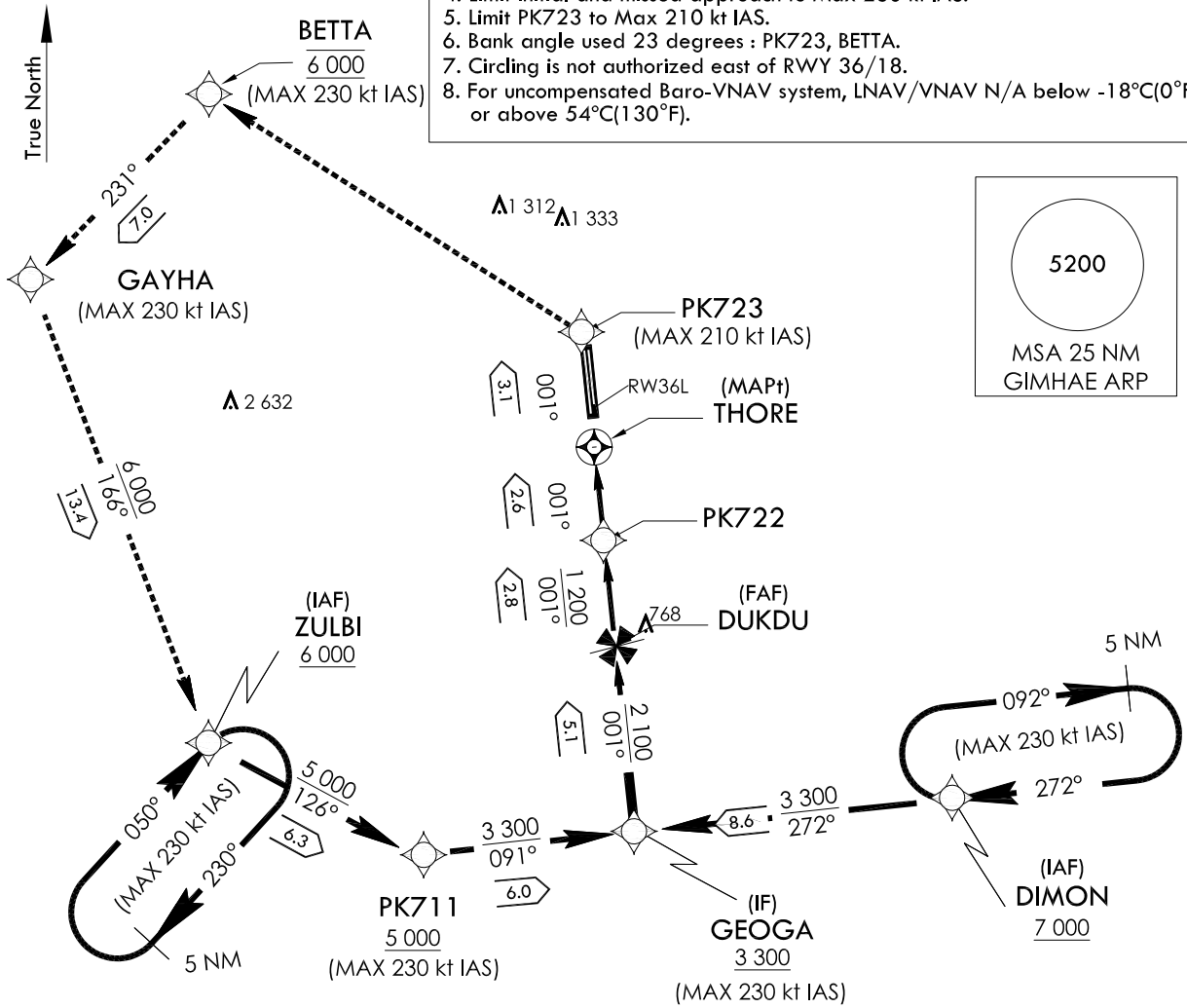

NOT TO SCALE

GNSS and RADAR Required

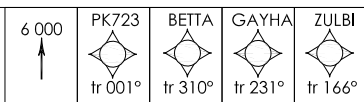

TRANSITION ALT 14 000  
TRANSITION LVL FL 140

**MISSED APPROACH :**

Climb to 6 000 ft on track 001° to PK723, then track 310° to cross BETTA at 6 000 ft, then track 231° to GAYHA, then track 166° to ZULBI and hold

Note : VGSI and RNAV glidepath not coincident  
(VGSI Angle 3.00° TCH 67)

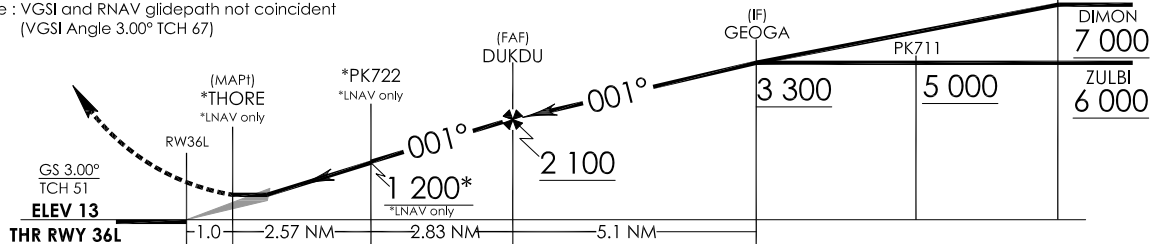

CATEGORY		A	B	C	D
LNAV /VNAV	FULL		420/45 408(500- $\frac{2}{3}$ )		
	ALS inop		420-1 $\frac{2}{3}$ 408(500-1 $\frac{2}{3}$ )		
LNAV	FULL	500/45 488(500- $\frac{2}{3}$ )		500/55 488(500-1)	
	ALS inop		500-1 $\frac{1}{2}$ 488(500-1 $\frac{1}{2}$ )		
CIRCLING		580-1 $\frac{1}{2}$ 567(600-1 $\frac{1}{2}$ )		1 360-3 1 347(1 400-3)	1 700-3 1 687(1 700-3)

Change : Page control.

BUSAN/Gimhae INTL(RKPK)  
RNAV(GNSS)  
RWY 36L

AERONAUTICAL DATA TABULATION

Instrument Approach Procedure Coding Tables

RNAV(GNSS) RWY 36L - via DIMON to GEOGA(IF)

Serial Number	Path Descriptor	Waypoint Identifier	Fly-over	Course/Track °M(T)	Distance (NM)	Turn direction	Altitude (ft)	Speed (kt)	Coordinates	VPA/TCH	Navigation specification	Remarks
001	-	DIMON	-	-	-	-	+7 000	-230	34°59'23.1"N 129°08'15.3"E	-	RNP APCH	IAF
002	TF	GEOGA	-	271.5(264.1)	8.6	-	+3 300	-230	34°58'29.0"N 128°57'48.0"E	-	RNP APCH	IF

RNAV(GNSS) RWY 36L - via ZULBI to GEOGA(IF)

Serial Number	Path Descriptor	Waypoint Identifier	Fly-over	Course/Track °M(T)	Distance (NM)	Turn direction	Altitude (ft)	Speed (kt)	Coordinates	VPA/TCH	Navigation specification	Remarks
001	-	ZULBI	-	-	-	-	+6 000	-230	35°00'51.7"N 128°43'47.2"E	-	RNP APCH	IAF
002	TF	PK711	-	125.8(118.3)	6.3	-	+5 000	-230	34°57'51.9"N 128°50'32.3"E	-	RNP APCH	SDF
002	TF	GEOGA	-	091.5(084.1)	6.0	-	+3 300	-230	34°58'29.0"N 128°57'48.0"E	-	RNP APCH	IF

RNAV(GNSS) RWY 36L - via GEOGA(IF) to MAHF

Serial Number	Path Descriptor	Waypoint Identifier	Fly-over	Course/Track °M(T)	Distance (NM)	Turn direction	Altitude (ft)	Speed (kt)	Coordinates	VPA/TCH	Navigation specification	Remarks
001	TF	GEOGA	-	-	-	-	+3 300	-230	34°58'29.0"N 128°57'48.0"E	-	RNP APCH	IF
002	TF	DUKDU	-	001.4(354.0)	5.1	-	+2 100	-	35°03'32.1"N 128°57'09.1"E	-	RNP APCH	FAF
003	TF	PK722	-	001.4(354.0)	2.83	-	+1 200	-	35°06'21.1"N 128°56'47.3"E	-	RNP APCH	SDF
004	TF	THORE	Y	001.4(354.0)	2.57	-	+500	-	35°08'54.9"N 128°56'27.5"E	-	RNP APCH	MAP1
005	TF	PK723	-	001.4(354.0)	3.08	-	-	-210	35°11'59.2"N 128°56'03.7"E	-	RNP APCH	CG 390 ft/NM to 6 000
006	TF	BETTA	-	310.0(302.5)	11.9	-	-	-230	35°18'24.2"N 128°43'46.2"E	-	RNP APCH	CG 390 ft/NM to 6 000
007	TF	GAYHA	-	231.2(223.8)	7.0	-	-	-230	35°13'22.4"N 128°37'54.4"E	-	RNP APCH	-
008	TF	ZULBI	-	166.3(158.9)	13.4	-	+6 000	-230	35°00'51.7"N 128°43'47.2"E	-	RNP APCH	-
009	H1M	DIMON	-	271.7(264.2)	5.0	R	-8 000 +7 000	-230	34°59'23.1"N 129°08'15.3"E	-	-	-
010	H1M	ZULBI	-	050(042.5)	5.0	R	-10 000 +6 000	-230	35°00'51.7"N 128°43'47.2"E	-	-	-

**INSTRUMENT  
APPROACH  
CHART**

**AERODROME ELEV 13 ft**  
HEIGHTS RELATED TO  
RWY 36L ELEV TDZ 13 ft

GIMHAE APP 125.5 364.0  
GIMHAE TWR 118.1 118.45  
233.3 236.6

**BUSAN/Gimhae Intl(RKPK)**  
**VOR/DME**  
**RWY 36L**

Note : Approach and circle to land under U.S. TERPS.

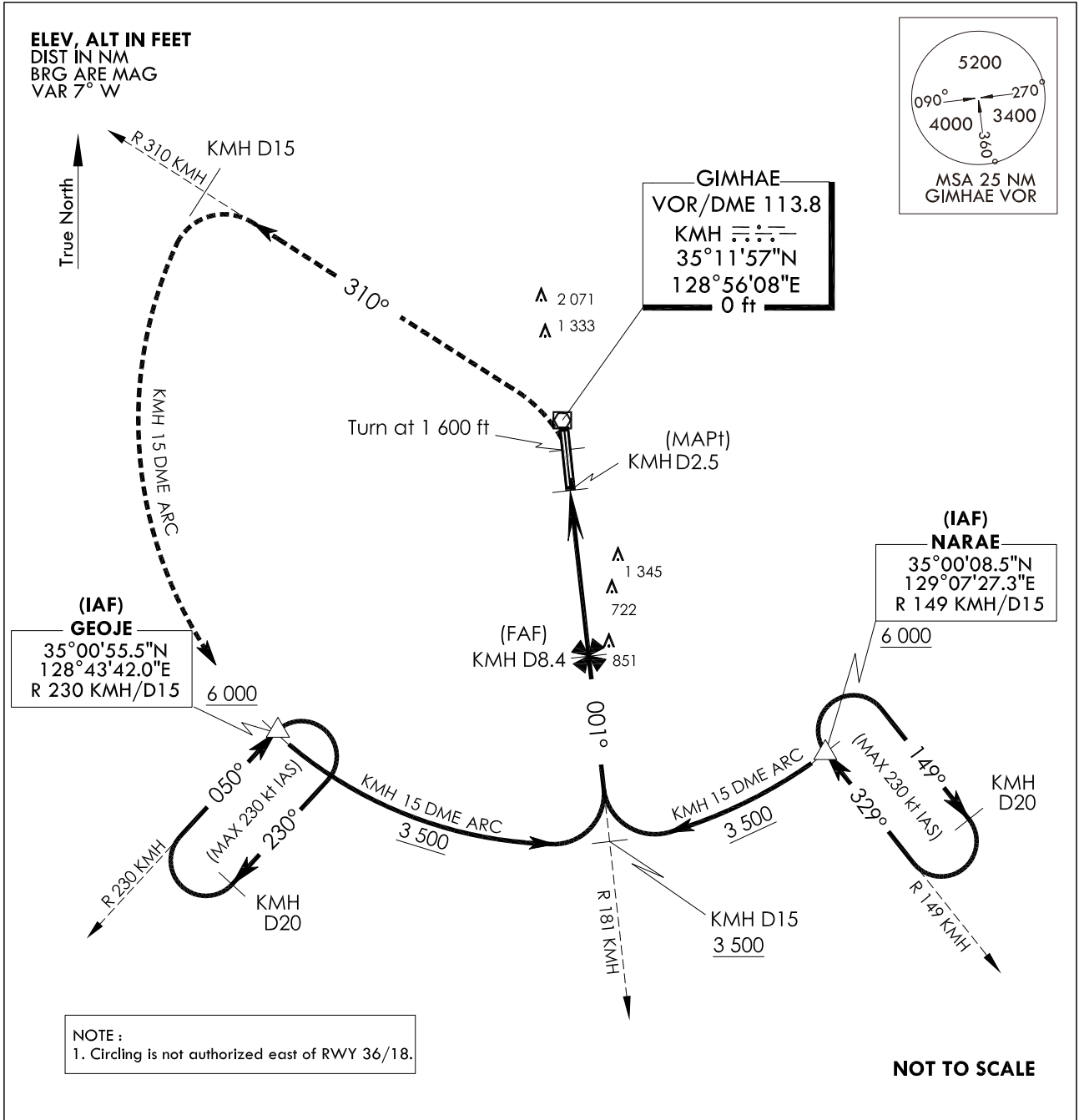

1 600	6 000	KMH D15	KMH D15 ARC	GEOJE	<b>MISSED APPROACH :</b> Climb to 1 600 ft then left turn climbing 6 000 ft on R 310 KMH to 15 DME, then ARC KMH 15 DME to GEOJE and hold.	TRANSITION ALT 14 000 TRANSITION LVL FL 140
-------	-------	---------	-------------	-------	---	--

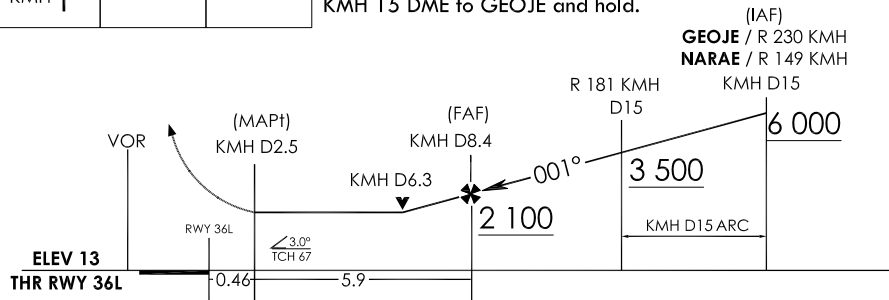

CATEGORY	A	B	C	D
S-VOR 36L	FULL 1 460/40 1 448(1 500 - 3/4)	1 460/55 1 448(1 500 - 1)	1 460 - 3	1 448(1 500 - 3)
	ALS inop 1 460/60 1 448(1 500-1 1/4)	1 460-1 1/2 1 448(1 500-1 1/2)		
CIRCLING	1 460 -1 1/4 1 447(1 500 - 1 1/4)	1 460 -1 1/2 1 447(1 500 - 1 1/2)	1 460 -3 1 447(1 500 - 3)	1 700 -3 1 687(1 700 - 3)

Change : Page control.

**INTENTIONALLY**

**LEFT**

**BLANK**

**INSTRUMENT APPROACH CHART**  
**AERODROME ELEV 13 ft**  
HEIGHTS RELATED TO  
RWY 36R ELEV TDZ 8 ft

GIMHAE APP	125.5	364.0
GIMHAE TWR	118.1	118.450
	233.3	236.6

**BUSAN/Gimhae Intl(RKPK)**  
**ILS Y**  
**RWY 36R**

Note : Approach and circle to land under U.S. TERPS.

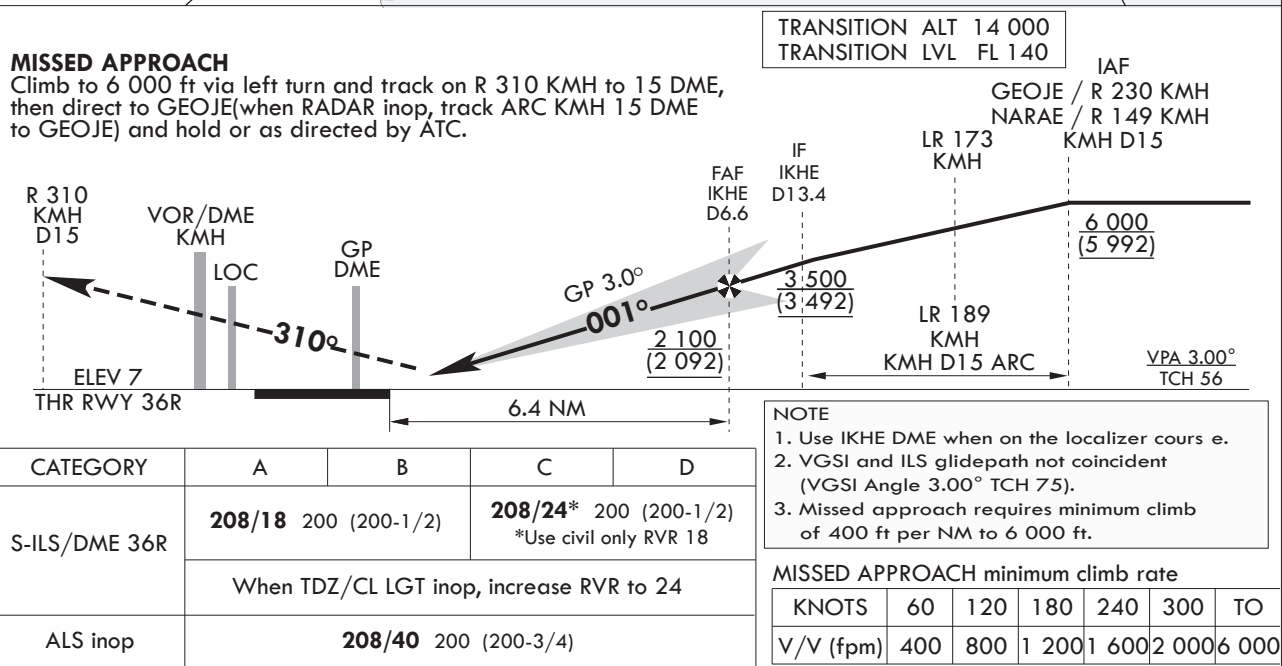
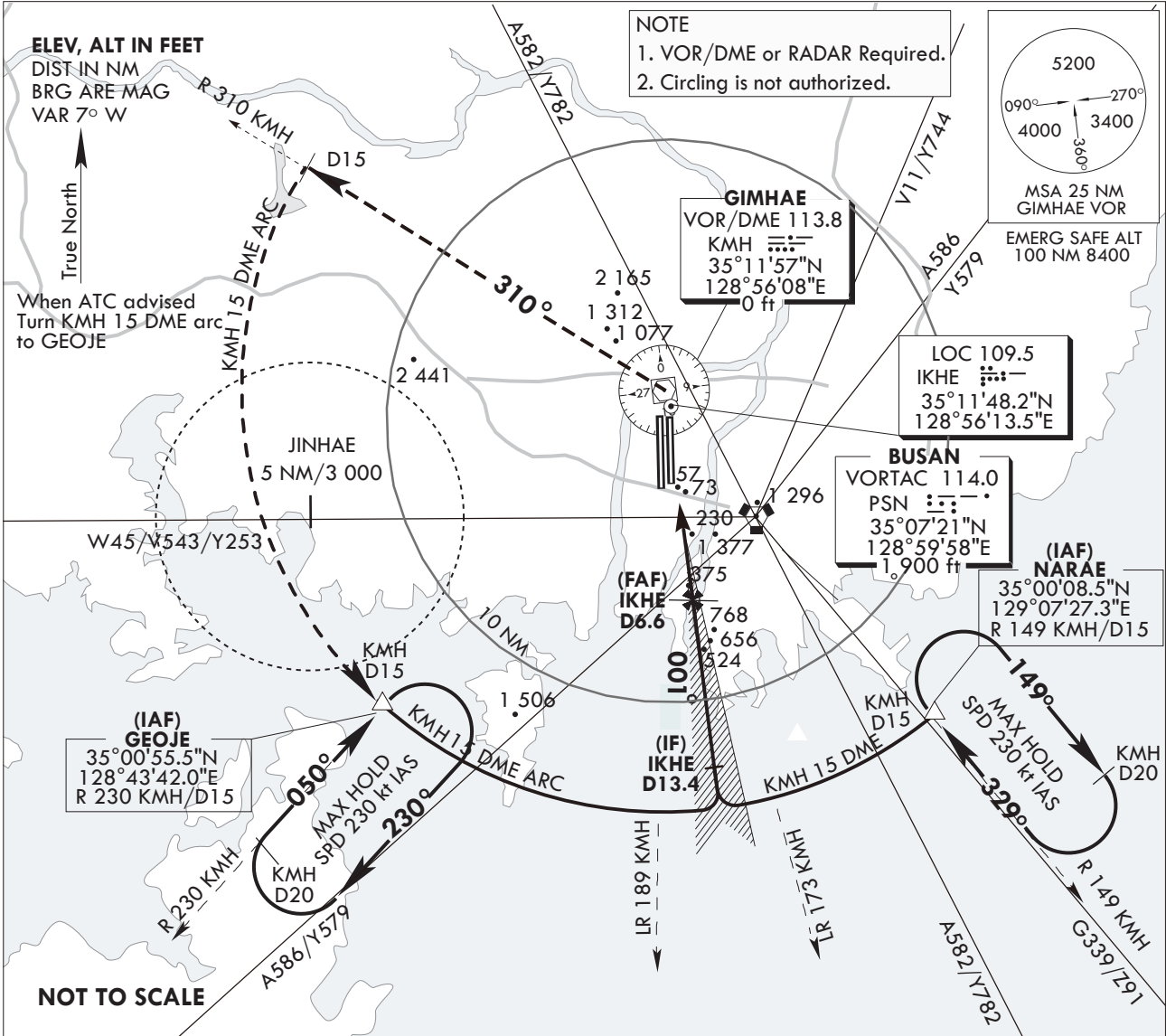

Change : Page control.

**INTENTIONALLY**

**LEFT**

**BLANK**



**INSTRUMENT  
APPROACH  
CHART**

**AERODROME ELEV 13 ft**  
HEIGHTS RELATED TO  
THR RWY 36R - ELEV 7 ft

GIMHAE APP	125.5	364.0
GIMHAE TWR	118.1	118.450
	233.3	236.6

**BUSAN/Gimhae Intl(RKPK)**  
**LOC/DME Y**  
**RWY 36R**

Note : Approach and circle to land under U.S. TERPS.

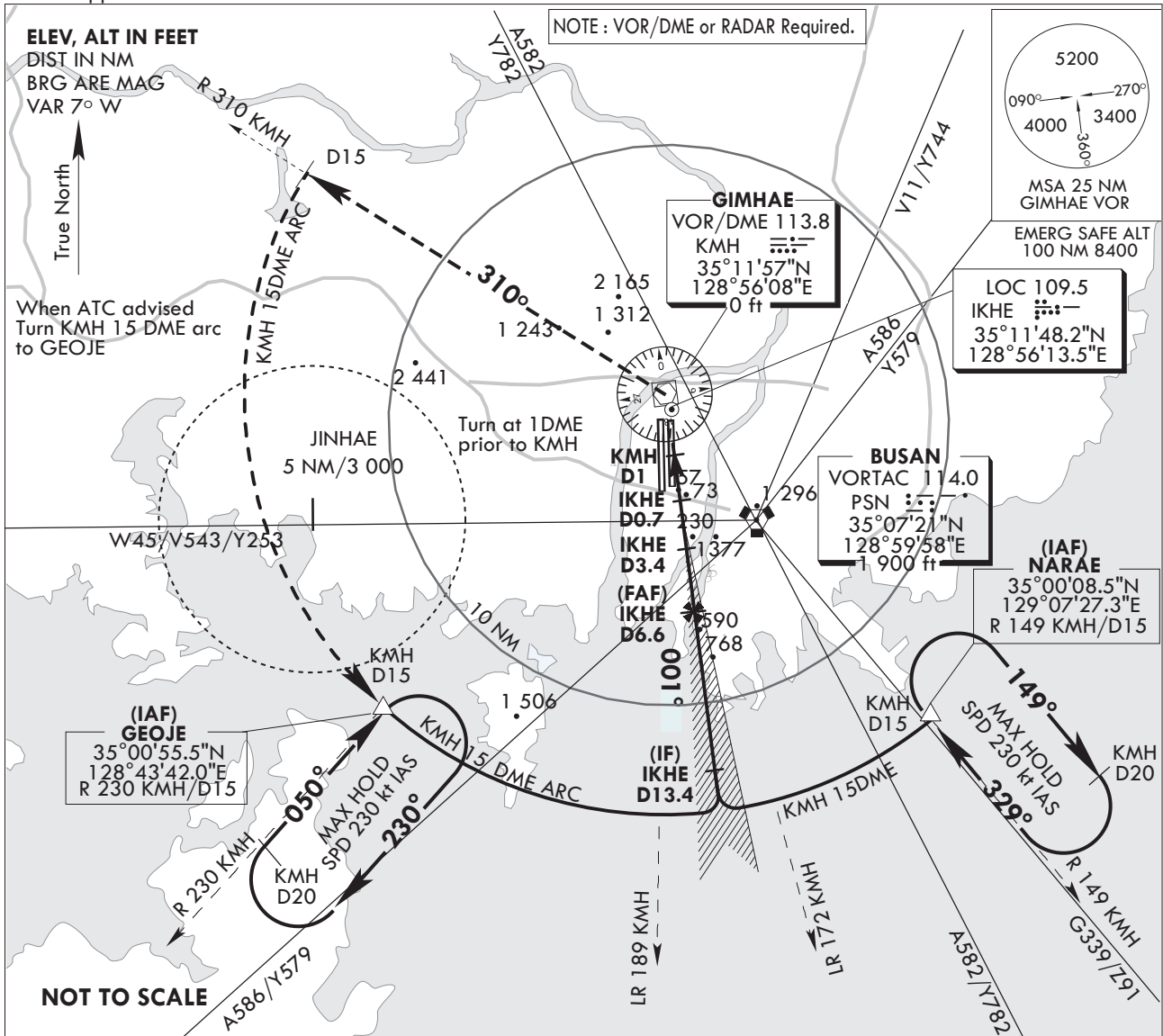

**MISSED APPROACH**

Climb to 6 000 ft via left turn and track on R 310 KMH to 15 DME, then direct to GEOJE (when RADAR inop, track ARC KMH 15 DME to GEOJE) and hold or as directed by ATC.

TRANSITION ALT 14 000  
TRANSITION LVL FL 140

IAF  
GEOJE / R 230 KMH  
NARAE / R 149 KMH  
KMH D15

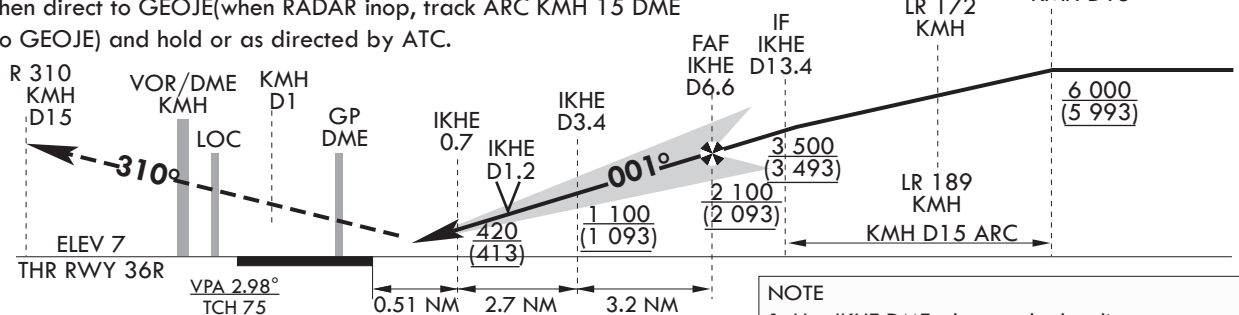

- NOTE**
1. Use IKHE DME when on the localizer course.
  2. Circling not authorized East of RWY 18L/36R.
  3. Missed approach requires minimum climb of 350 ft per NM to 6 000 ft.

CATEGORY	A	B	C	D
S-LOC/DME 36R	420/24	413 (500-1/2)	420/40	413 (500-3/4)
ALS inop	420/55	413(500-1)	420/60	413(500-11/8)
CIRCLING <b>C</b>	520-1	580-1	1 360-3	1 700-3
	507(600-1)	567(600-1)	1 347(1 400-3)	1 687(1 700-3)

MISSED APPROACH minimum climb rate

KNOTS	60	120	180	240	300	TO
V/V (fpm)	350	700	1 050	1 400	1 750	6 000

Change : Page control.

**INTENTIONALLY**

**LEFT**

**BLANK**

**INSTRUMENT APPROACH CHART**

**AERODROME ELEV 13 ft**  
HEIGHTS RELATED TO  
RWY 36R ELEV TDZ 8 ft

GIMHAE APP	125.5	364.0
GIMHAE TWR	118.1	118.45
	233.3	236.6

**BUSAN/Gimhae Intl(RKPK)**  
ILS Z  
RWY 36R

Note : Approach and circle to land under U.S. TERPS.

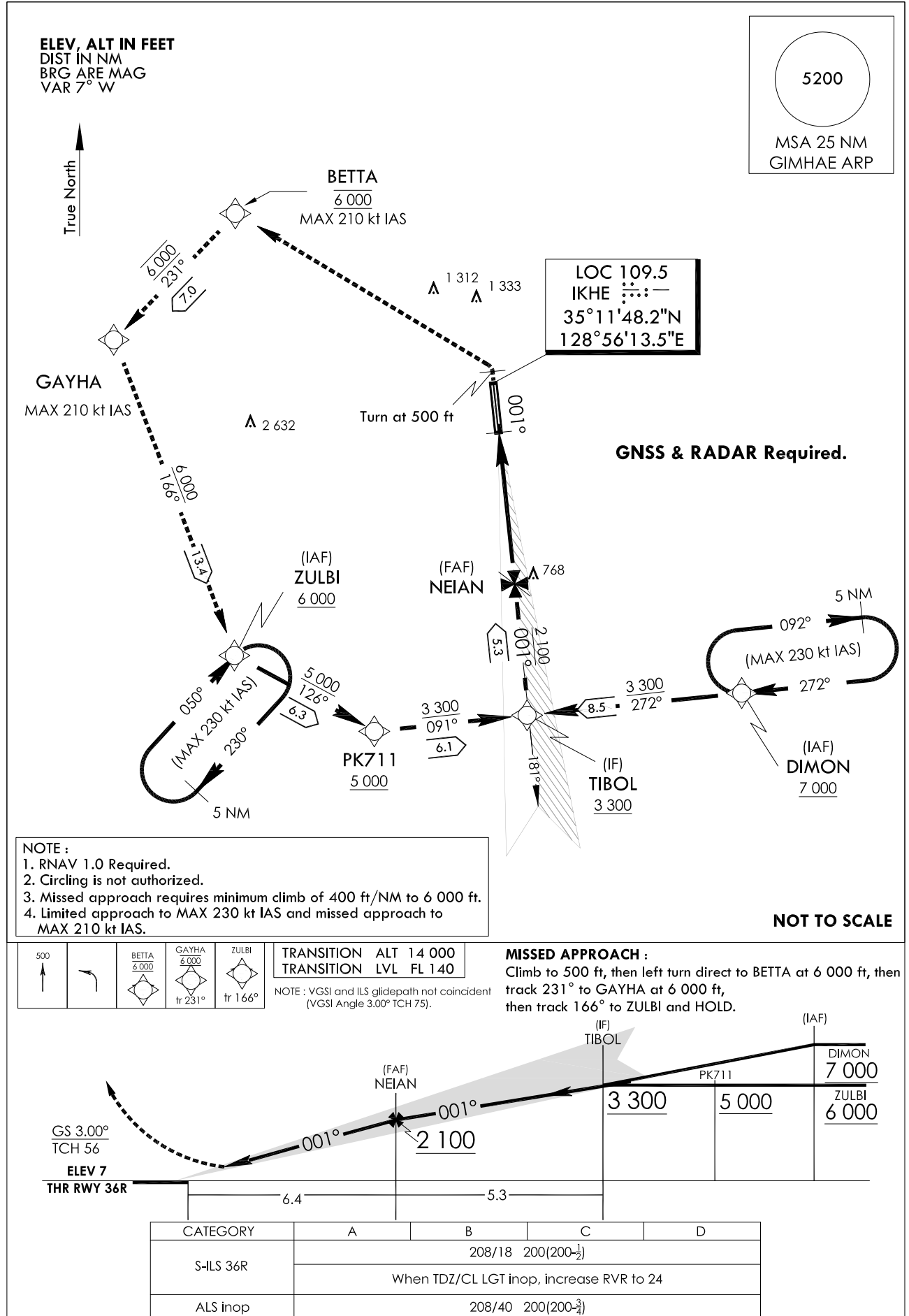

Change : Page control.

BUSAN/Gimhae INTL(RKPK)

ILS Z  
RWY 36R

AERONAUTICAL DATA TABULATION

Instrument Approach Procedure Coding Tables

ILS Z Approach to RWY 36R from DIMON to TIBOL(IF)

Serial Number	Path Descriptor	Waypoint Identifier	Fly-over	Course/Track °M(T)	Distance (NM)	Turn direction	Altitude (ft)	Speed (kt)	Coordinates	VPA/TCH	Navigation specification	Remarks
001	-	DIMON	-	-	-	-	+7 000	-230	34°59'23.1"N 129°08'15.3"E	-	RNAV 1	IAF
002	TF	TIBOL	-	271.7(264.2)	8.5	-	+3 300	-230	34°58'31.2"N 128°57'56.1"E	-	RNAV 1	IF

ILS Z Approach to RWY 36R from ZULBI to TIBOL(IF)

Serial Number	Path Descriptor	Waypoint Identifier	Fly-over	Course/Track °M(T)	Distance (NM)	Turn direction	Altitude (ft)	Speed (kt)	Coordinates	VPA/TCH	Navigation specification	Remarks
001	-	ZULBI	-	-	-	-	+6 000	-230	35°00'51.7"N 128°43'47.2"E	-	RNAV 1	IAF
002	TF	PK711	-	125.8(118.3)	6.3	-	+5 000	-230	34°57'51.9"N 128°50'32.3"E	-	RNAV 1	SDF
002	TF	TIBOL	-	091.3(083.8)	6.1	-	+3 300	-230	34°58'31.2"N 128°57'56.1"E	-	RNAV 1	IAF/IF

ILS Z Approach to RWY 36R from TIBOL(IF) to MAHF

Serial Number	Path Descriptor	Waypoint Identifier	Fly-over	Course/Track °M(T)	Distance (NM)	Turn direction	Altitude (ft)	Speed (kt)	Coordinates	VPA/TCH	Navigation specification	Remarks
001	TF	TIBOL	-	-	-	-	+3 300	-230	34°58'31.2"N 128°57'56.1"E	-	RNAV 1	IF
002	TF	NEIAN	-	001.4(354.0)	5.3	-	+2 100	-	35°03'46.6"N 128°57'15.5"E	-	-	FAF
003	-	DA	-	001.4(354.0)	-	-	+208	-	-	-	LOC	DA
004	-	RWY 36R	-	001.4(354.0)	-	-	-	-	35°10'10.10"N 128°56'26.14"E	3.0/56	LOC	-
005	DF	BETTA	-	-	-	L	@6 000	-210	35°18'24.2"N 128°43'46.2"E	-	RNAV 1	CG 400 ft/NM to 6 000
006	TF	GAYHA	-	231.3(223.8)	7.0	-	@6 000	-210	35°13'22.4"N 128°37'54.4"E	-	RNAV 1	-
007	TF	ZULBI	-	166.3(158.9)	13.4	-	+6 000	-230	35°00'51.7"N 128°43'47.2"E	-	RNAV 1	-
008	H/M	DIMON	-	271.7(264.2)	5.0	R	+8 000 +7 000	-230	34°59'23.1"N 129°08'15.3"E	-	-	-
009	H/M	ZULBI	-	050(042.5)	5.0	R	+10 000 +6 000	-230	35°00'51.7"N 128°43'47.2"E	-	-	-

**INSTRUMENT  
APPROACH  
CHART**

**AERODROME ELEV 13 ft**  
HEIGHTS RELATED TO  
RWY 36R ELEV TDZ 8 ft

GIMHAE APP 125.5 364.0  
GIMHAE TWR 118.1 118.45  
233.3 236.6

**BUSAN/Gimhae Int'l(RKPK)**  
**LOC/DME Z**  
**RWY 36R**

Note : Approach and circle to land under U.S. TERPS.

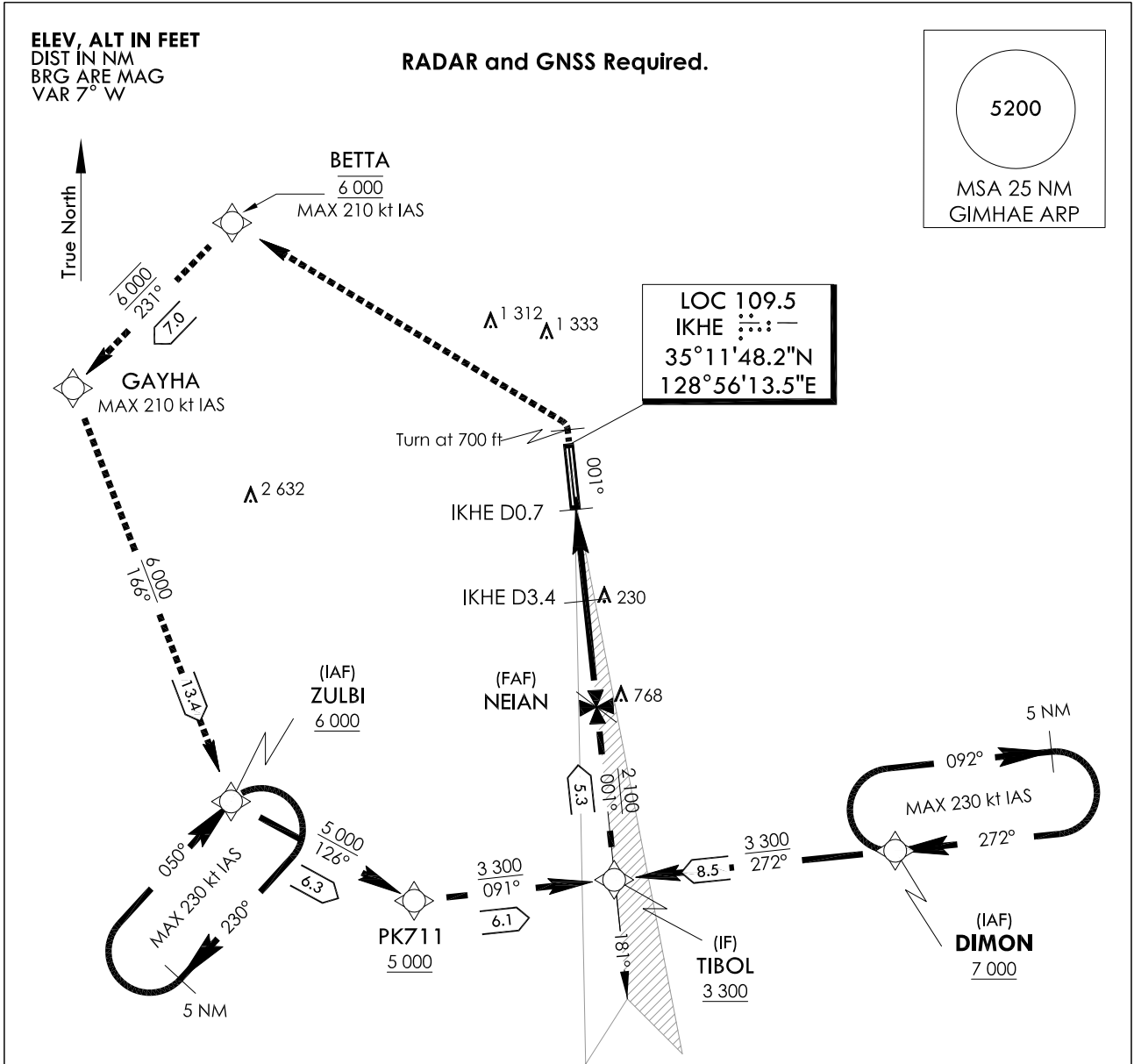

**NOTE :**  
1. RNAV 1.0 Required.  
2. Circling is not authorized east of RWY 36/18.  
3. Missed approach requires minimum climb of 350 ft/NM to 6 000 ft.  
4. Limited approach to MAX 230 kt IAS and missed approach to MAX 210 kt IAS.

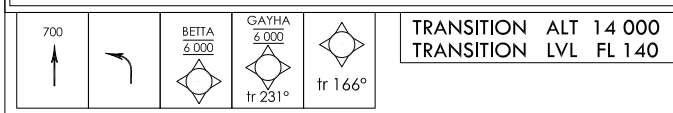

**MISSED APPROACH :**  
Climb to 700 ft, then left turn direct to BETTA at 6 000 ft, then track 231° to GAYHA at 6 000 ft, then track 166° to ZULBI and HOLD.

NOTE : Use IKHE DME when on the localizer course.

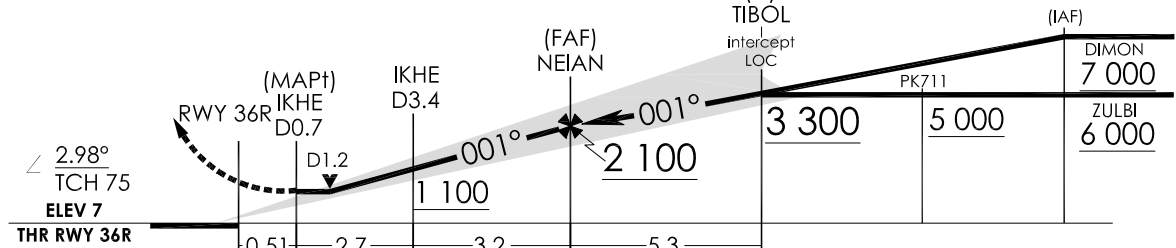

CATEGORY		A	B	C	D
S-LOC 36R	FULL	420/24	413(500- $\frac{1}{2}$ )	420/40	413(500- $\frac{3}{8}$ )
	ALS inop	420/55	413(500-1)	420/60	413(500-1 $\frac{1}{8}$ )
CIRCLING		520-1 507(600-1)	580-1 567(600-1)	1 360-3 1 347(1 400-3)	1 700-3 1 687(1 700-3)

Change : Page control.

BUSAN/Gimhae INTL(RKPK)  
LOC/DME Z  
RWY 36R

AERONAUTICAL DATA TABULATION

Instrument Approach Procedure Coding Tables

LOC/DME Z Approach to RWY 36R from DIMON to TIBOL(IF)

Serial Number	Path Descriptor	Waypoint Identifier	Fly-over	Course/Track °M(°T)	Distance (NM)	Turn direction	Altitude (ft)	Speed (kt)	Coordinates	VPA/TCH	Navigation specification	Remarks
001	-	DIMON	-	-	-	-	+7 000	-230	34°59'23.1"N 129°08'15.3"E	-	RNAV 1	IAF
002	TF	TIBOL	-	271.7(264.2)	8.5	-	+3 300	-230	34°58'31.2"N 128°57'56.1"E	-	RNAV 1	IF

LOC/DME Z Approach to RWY 36R from ZULBI to TIBOL(IF)

Serial Number	Path Descriptor	Waypoint Identifier	Fly-over	Course/Track °M(°T)	Distance (NM)	Turn direction	Altitude (ft)	Speed (kt)	Coordinates	VPA/TCH	Navigation specification	Remarks
001	-	ZULBI	-	-	-	-	+6 000	-230	35°00'51.7"N 128°43'47.2"E	-	RNAV 1	IAF
002	TF	PK711	-	125.8(118.3)	6.3	-	+5 000	-230	34°57'51.9"N 128°50'32.3"E	-	RNAV 1	SDF
002	TF	TIBOL	-	091.3(083.8)	6.1	-	+3 300	-230	34°58'31.2"N 128°57'56.1"E	-	RNAV 1	IF

LOC/DME Z Approach to RWY 36R from TIBOL(IF) to MAHF

Serial Number	Path Descriptor	Waypoint Identifier	Fly-over	Course/Track °M(°T)	Distance (NM)	Turn direction	Altitude (ft)	Speed (kt)	Coordinates	VPA/TCH	Navigation specification	Remarks
001	TF	TIBOL	-	-	-	-	+3 300	-230	34°58'31.2"N 128°57'56.1"E	-	RNAV 1	IF
002	TF	NEIAN	-	001.4(354.0)	5.3	-	+2 100	-	35°03'46.6"N 128°57'15.5"E	-	LOC	FAF
003	-	IKHE 3.4D	-	001.4(354.0)	3.2	-	+1 100	-	35°06'57.8"N 128°56'50.9"E	-	LOC	SDF
004	-	IKHE 0.7D	-	001.4(354.0)	2.7	-	+420	-	35°09'39.4"N 128°56'30.1"E	-	LOC	MAPt
005	-	RWY 36R	-	001.4(354.0)	0.51	-	-	-	35°10'10.1"N 128°56'26.14"E	3.0/56	LOC	-
006	DF	BETTA	-	-	-	L	@6 000	-210	35°18'24.2"N 128°43'46.2"E	-	RNAV 1	CG 350 ft/NM to 6 000
007	TF	GAYHA	-	231.3(223.8)	7.0	-	@6 000	-210	35°13'22.4"N 128°37'54.4"E	-	RNAV 1	-
008	TF	ZULBI	-	166.3(158.9)	13.4	-	+6 000	-230	35°00'51.7"N 128°43'47.2"E	-	RNAV 1	-
009	HM	DIMON	-	271.7(264.2)	5.0	R	-8 000 +7 000	-230	34°59'23.1"N 129°08'15.3"E	-	-	-
010	HM	ZULBI	-	050(042.5)	5.0	R	-10 000 +6 000	-230	35°00'51.7"N 128°43'47.2"E	-	-	-

**INSTRUMENT  
APPROACH  
CHART**

**AERODROME ELEV 13 ft**  
**HEIGHTS RELATED TO**  
**RWY 36R ELEV TDZ 13 ft**

GIMHAE APP 125.5 364.0  
GIMHAE TWR 118.1 118.45  
233.3 236.6

**BUSAN/Gimhae Intl(RKPK)**  
**RNAV(GNSS)**  
**RWY 36R**

Note : Approach and circle to land under U.S. TERPS.

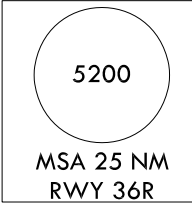
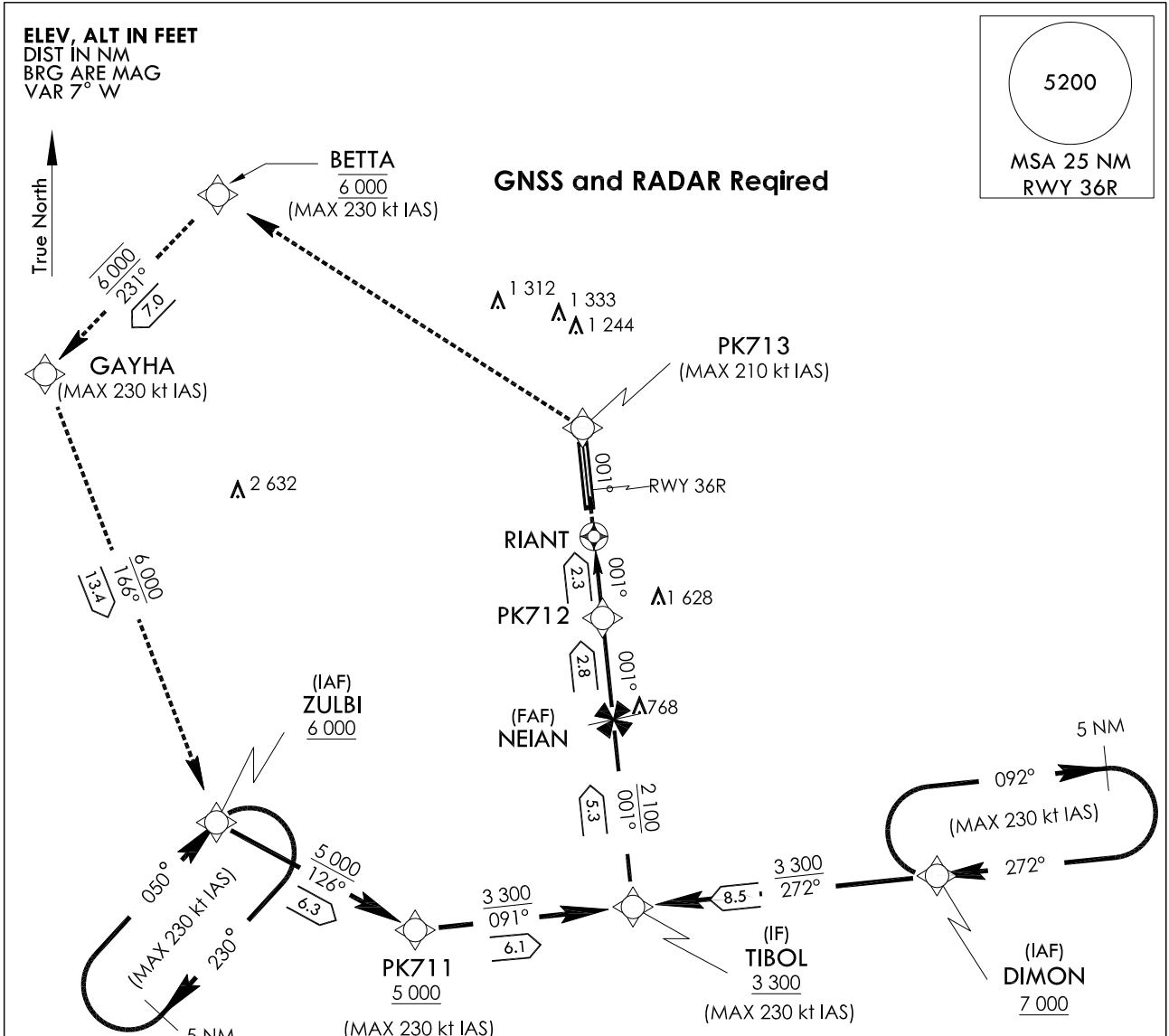

**ELEV, ALT IN FEET**  
**DIST IN NM**  
**BRG ARE MAG**  
**VAR 7° W**

**GNSS and RADAR Required**

- NOTE :**
1. RNP 0.3 Required.
  2. DME/DME RNP 0.3 N/A.
  3. Missed approach requires minimum climb of 330 ft/NM to 6 000 ft.
  4. Limit initial and missed approach to MAX 230 kt IAS.
  5. Limit PK713 to MAX 210 kt IAS.
  6. Bank angle used 23 degrees : PK713, BETTA
  7. Circling is not authorized east of RWY 36/18.
  8. For uncompensated Baro-VNAV system, LNAV/VNAV N/A below -18°C(0°F) or above 54°C(130°F).

**NOT TO SCALE**

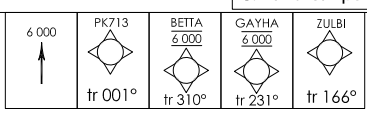

TRANSITION ALT	14 000
TRANSITION LVL	FL 140

**MISSED APPROACH :**  
Climb to 6 000 on track 001° to PK713, then track 310° to BETTA, then track 231° to GAYHA, then track 166° to ZULBI and hold (IAF)

Note : VGSI and RNAV glidepath not coincident (VGSI Angle 3.00° TCH 75)

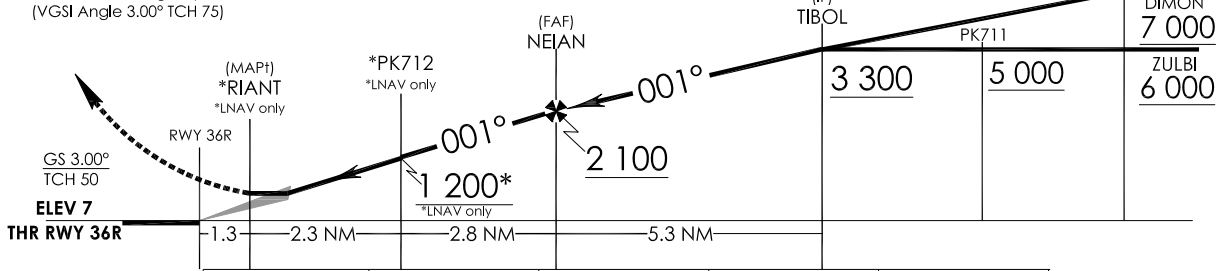

CATEGORY		A		B		C		D	
		1	2	1	2	1	2	1	2
LNAV /VNAV	FULL			420/55	413(500-1)				
	ALS inop			420/60	413(500-1 1/4)				
LNAV	FULL			600-1 1/2	593(600-1 1/2)				
	ALS inop			600-1 7/8	593(600-1 7/8)				
CIRCLING				600-1 7/8		1 360-3	1 347(1 400-3)	1 700-3	1 687(1 700-3)
				587(600-1 7/8)					

Change : Page control.

**BUSAN/Gimhae INTL(RKPK)**  
**RNAV(GNSS)**  
**RWY 36L**

**AERONAUTICAL DATA TABULATION**

**Instrument Approach Procedure Coding Tables**

RNAV(GNSS) RWY 36R - via DIMON to TIBOL(IF)

Serial Number	Path Descriptor	Waypoint Identifier	Fly-over	Course/Track °M(T)	Distance (NM)	Turn direction	Altitude (ft)	Speed (kt)	Coordinates	VPA/TCH	Navigation specification	Remarks
001	-	DIMON	-	-	-	-	+7 000	-230	34°59'23.1"N 129°08'15.3"E	-	RNP APCH	IAF
002	TF	TIBOL	-	271.7(264.2)	8.5	-	+3 300	-230	34°58'31.2"N 128°57'56.1"E	-	RNP APCH	IF

RNAV(GNSS) RWY 36R - via ZULBI to TIBOL(IF)

Serial Number	Path Descriptor	Waypoint Identifier	Fly-over	Course/Track °M(T)	Distance (NM)	Turn direction	Altitude (ft)	Speed (kt)	Coordinates	VPA/TCH	Navigation specification	Remarks
001	-	ZULBI	-	-	-	-	+6 000	-230	35°00'51.7"N 128°43'47.2"E	-	RNP APCH	IAF
002	TF	PK711	-	125.8(118.3)	6.3	-	+5 000	-230	34°57'51.9"N 128°50'32.3"E	-	RNP APCH	SDF
002	TF	TIBOL	-	091.3(083.8)	6.1	-	+3 300	-230	34°58'31.2"N 128°57'56.1"E	-	RNP APCH	IF

RNAV(GNSS) RWY 36R - via TIBOL(IF) to MAHF

Serial Number	Path Descriptor	Waypoint Identifier	Fly-over	Course/Track °M(T)	Distance (NM)	Turn direction	Altitude (ft)	Speed (kt)	Coordinates	VPA/TCH	Navigation specification	Remarks
001	TF	TIBOL	-	-	-	-	+3 300	-230	34°58'31.2"N 128°57'56.1"E	-	RNP APCH	IF
002	TF	NEIAN	-	001.4(354.0)	5.3	-	+2 100	-	35°03'46.6"N 128°57'15.5"E	-	RNP APCH	FAF
003	TF	PK712	-	001.4(354.0)	2.8	-	+1 200	-	35°06'35.6"N 128°56'53.8"E	-	RNP APCH	SDF
004	TF	RIANT	Y	001.4(354.0)	2.3	-	+600	-	35°08'52.4"N 128°56'36.2"E	-	RNP APCH	MAPI
005	TF	PK713	-	001.4(354.0)	3.1	-	-	-210	35°11'54.5"N 128°56'12.8"E	-	RNP APCH	CG 330 ft/NM to 6 000
006	TF	BETTA	-	310.0(302.5)	12.1	-	-	-230	35°18'24.2"N 128°43'46.2"E	-	RNP APCH	CG 330 ft/NM to 6 000
007	TF	GAYHA	-	231.2(223.8)	7.0	-	-	-230	35°13'22.4"N 128°37'54.4"E	-	RNP APCH	CG 330 ft/NM to 6 000
008	TF	ZULBI	-	166.3(158.9)	13.4	-	+6 000	-230	35°00'51.7"N 128°43'47.2"E	-	RNP APCH	-
009	HM	DIMON	-	271.7(264.2)	5.0	R	-8 000 +7 000	-230	34°59'23.1"N 129°08'15.3"E	-	-	-
010	HM	ZULBI	-	050(042.5)	5.0	R	-10 000 +6 000	-230	35°00'51.7"N 128°43'47.2"E	-	-	-



**INSTRUMENT  
APPROACH  
CHART**

**AERODROME ELEV 13 ft**  
HEIGHTS RELATED TO  
RWY 36R ELEV TDZ 8 ft

GIMHAE APP 125.5 364.0  
GIMHAE TWR 118.1 118.45  
233.3 236.6

**BUSAN/Gimhae Intl(RKPK)**  
**VOR/DME**  
**RWY 36R**

Note : Approach and circle to land under U.S. TERPS.

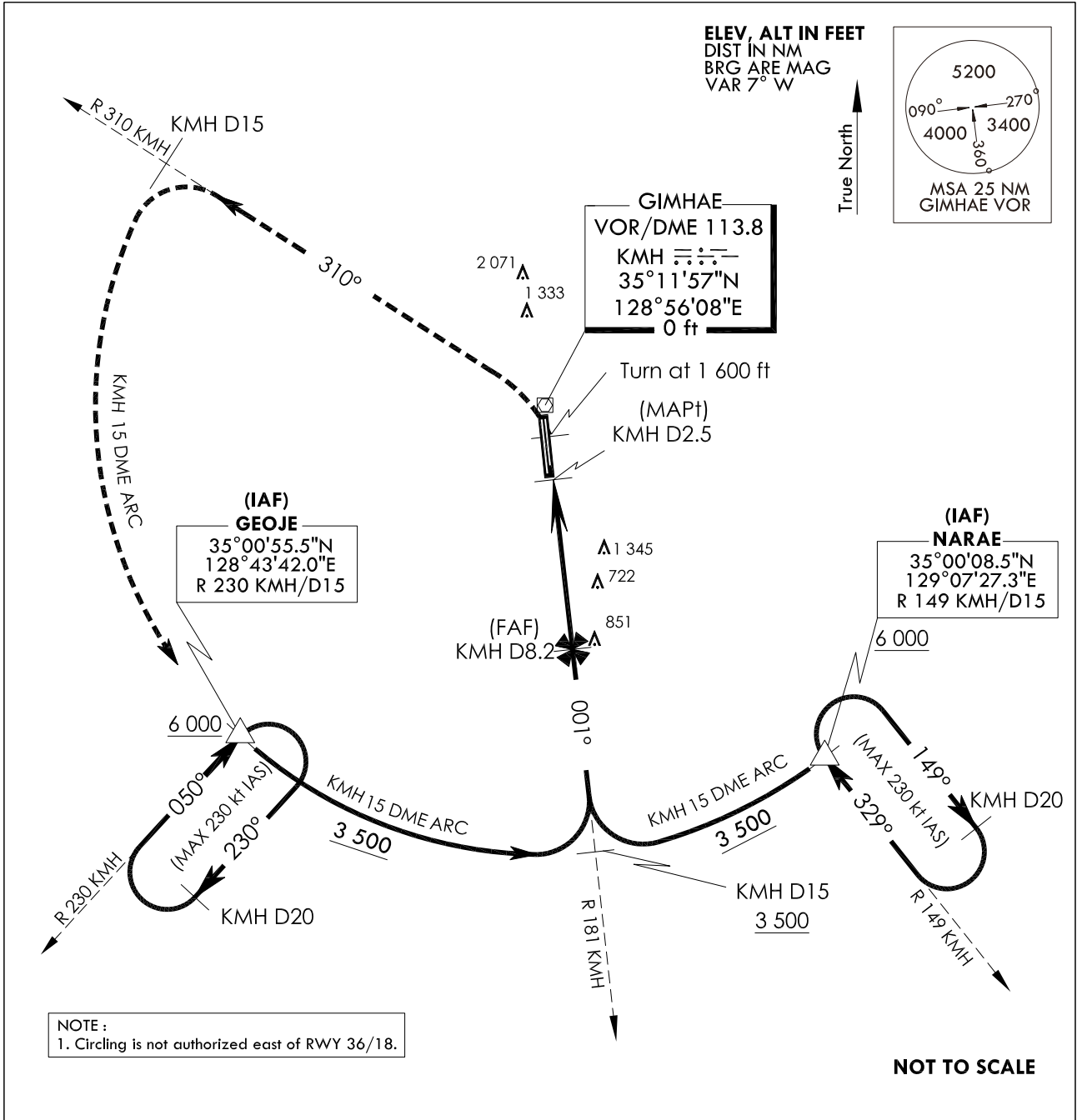

1 600	6 000	KMH D15	KMH D15 ARC	GEOJE	TRANSITION ALT 14 000	(IAF) GEOJE / R 230 KMH
↑	R 310 KM/H	↑	△		TRANSITION LVL FL 140	NARAE / R 149 KM/H
<p><b>MISSED APPROACH :</b> Climb to 1 600 ft then left turn climbing 6 000 ft on R 310 KM/H to 15 DME, then arc KM/H 15 DME to GEOJE and hold.</p>						
<p>ELEV 7 THR RWY 36R</p> <p>0.71      5.7</p> <p>∠2.97° TCH 75</p>						
CATEGORY		A	B	C	D	
S-VOR 36R	FULL	1 460/40	1 460/55			
	ALS inop	1 453(1 500 - 3/4)	1 453(1 500 - 1)	1 460 - 3	1 453(1 500 - 3)	
		1 460/60	1 460 - 1 1/2			
CIRCLING		1 453(1 500 - 1 1/4)	1 453(1 500 - 1 1/2)	1 460 - 3	1 700 - 3	
		1 460 - 1 1/4	1 460 - 1 1/2	1 447(1 500 - 3)	1 687(1 700 - 3)	
		1 447(1 500 - 1 1/4)	1 447(1 500 - 1 1/2)			

Change : Page control.

**INTENTIONALLY**

**LEFT**

**BLANK**

**INSTRUMENT  
APPROACH  
CHART**

**AERODROME ELEV 13 ft**  
HEIGHTS RELATED TO  
THR RWY 18L - ELEV 12 ft  
THR RWY 18R - ELEV 8 ft

GIMHAE APP 125.5 364.0  
GIMHAE TWR 118.1 233.3  
118.450 236.6

**BUSAN/Gimhae INTL(RKPK)**  
**VOR/DME - A**  
**RWY 18L/R**

Note : Approach and Circle to land under U.S TERPS.

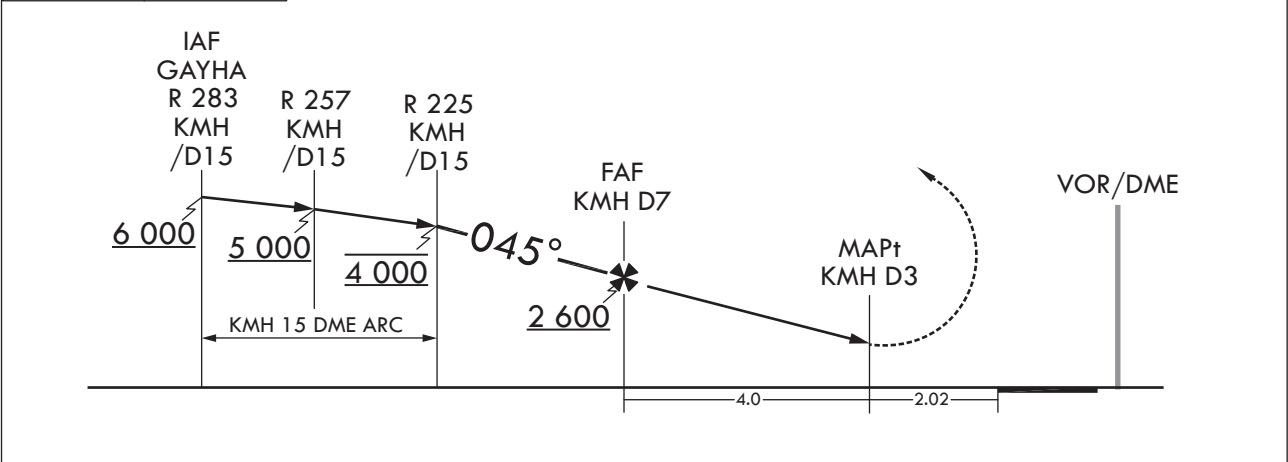
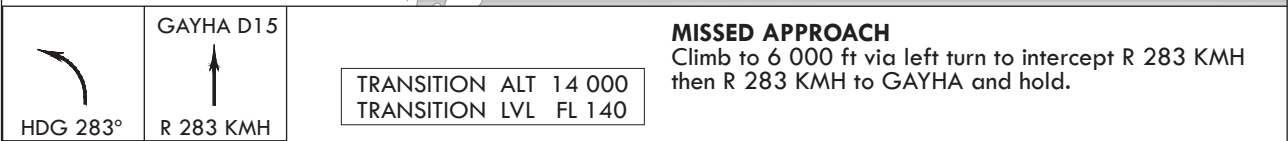
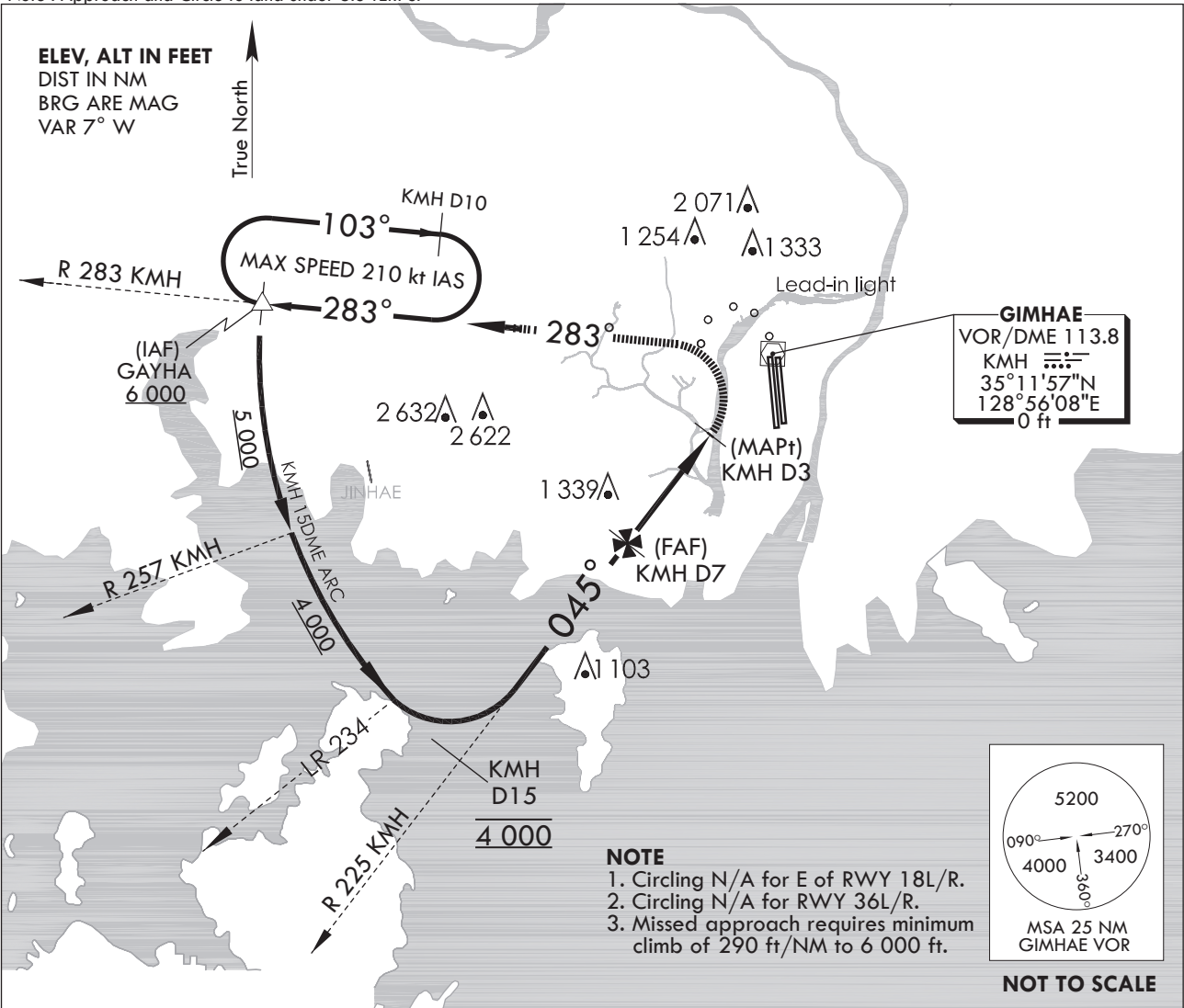

CATEGORY	A	B	C	D
CIRCLING		1 700 - 3	1 687(1 700 - 3)	

Change : Page control.

**INTENTIONALLY**

**LEFT**

**BLANK**

**INSTRUMENT  
APPROACH  
CHART**

**AERODROME ELEV 13 ft**

GIMHAE APP 125.5 364.0  
GIMHAE TWR 118.1 118.45  
233.3 236.6

**BUSAN/Gimhae Intl(RKPK)**

**RNAV(GNSS)-B  
RWY 18L/R**

Note : Approach and circle to land under U.S. TERPS.

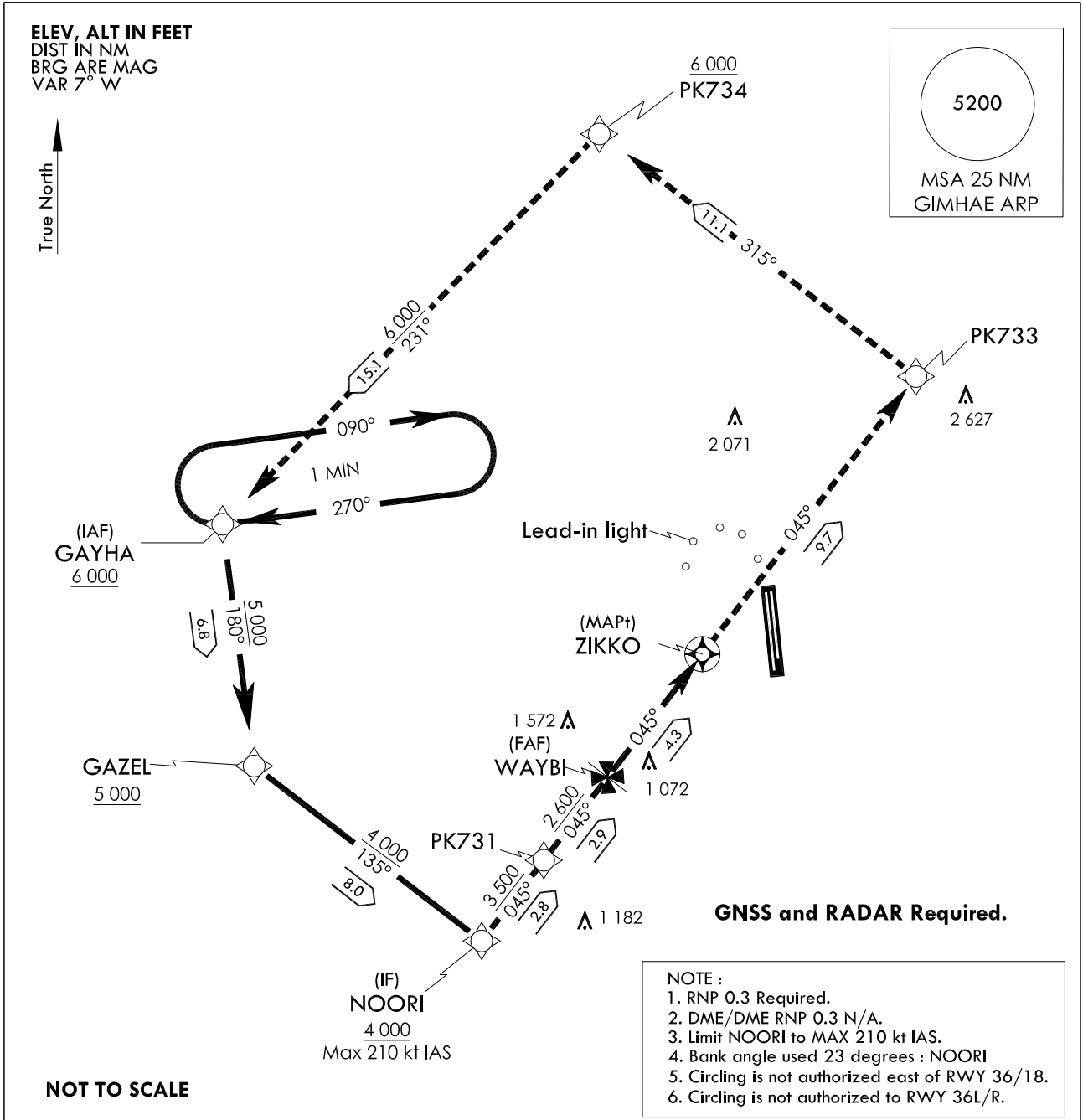

TRANSITION ALT 14 000  
TRANSITION LVL FL 140

**MISSED APPROACH :**  
Climb to 6 000 ft via track 045° to PK733 and track 315° to PK734, then track 231° to GAYHA and hold.

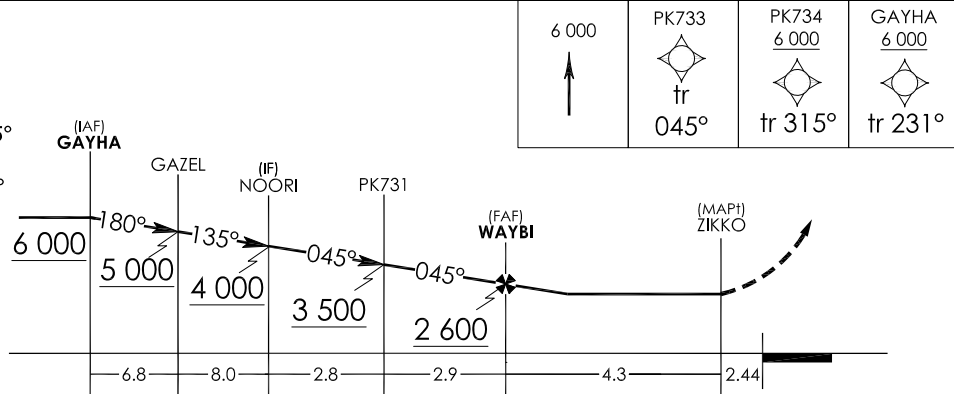

CATEGORY	A	B	C	D
LNAV/VNAV DA			N/A	
LNAV MDA			N/A	
CIRCLING		1 700-3	1 687(1 700-3)	

Change : Page control.

**BUSAN/Gimhae INTL(RKPK)**  
**RNAV(GNSS) - B**  
**RWY 18L/R**

**AERONAUTICAL DATA TABULATION**

**Instrument Approach Procedure Coding Tables**

RNAV(GNSS) - B

Serial Number	Path Descriptor	Waypoint Identifier	Fly-over	Course/Track °M(T)	Distance (NM)	Turn direction	Altitude (ft)	Speed (kt)	Coordinates	VPA/TCH	Navigation specification	Remarks
001	TF	GAYHA	-	-	-	-	+6 000	-	35°13'22.4"N 128°37'54.4"E	-	RNP APCH	IAF
002	TF	GAZEL	-	179.8(172.36)	6.75	-	+5 000	-	35°06'40.3"N 128°39'00.0"E	-	RNP APCH	-
003	TF	NOORI	-	134.8(127.37)	7.95	-	+4 000	-210	35°01'50.0"N 128°46'41.8"E	-	RNP APCH	IF
004	TF	PK731	-	044.9(037.44)	2.82	-	+3 500	-	35°04'04.7"N 128°48'47.2"E	-	RNP APCH	-
005	TF	WAYBI	-	044.9(037.46)	2.9	-	+2 600	-	35°06'23.0"N 128°50'56.2"E	-	RNP APCH	FAF
006	TF	ZIKKO	Y	044.9(037.48)	4.3	-	+1 700	-	35°09'48.1"N 128°54'07.8"E	-	RNP APCH	MAPt
007	TF	PK733	-	045.0(037.51)	9.7	-	+3 500	-	35°17'30.5"N 129°01'20.9"E	-	RNP APCH	-
008	TF	PK734	-	315.0(307.58)	11.07	-	+6 000	-	35°24'15.6"N 128°50'37.2"E	-	RNP APCH	-
009	TF	GAYHA	-	231.3(223.81)	15.05	-	+6 000	-	35°13'22.4"N 128°37'54.4"E	-	RNP APCH	-
010	HIM	GAYHA	-	270(262.5)	-	R	-10 000 +6 000	-210	35°13'22.4"N 128°37'54.4"E	-	-	<sup>1</sup> min (Inbound timing)

Change : Page control.